

# DVD PLAYER

# DVD-S550/DV-S5750

## SERVICE MANUAL

DVD-S550/DV-S5750

### IMPORTANT NOTICE

This manual has been provided for the use of authorized YAMAHA Retailers and their service personnel. It has been assumed that basic service procedures inherent to the industry, and more specifically YAMAHA Products, are already known and understood by the users, and have therefore not been restated.

**WARNING:** Failure to follow appropriate service and safety procedures when servicing this product may result in personal injury, destruction of expensive components, and failure of the product to perform as specified. For these reasons, we advise all YAMAHA product owners that any service required should be performed by an authorized YAMAHA Retailer or the appointed service representative.

**IMPORTANT:** The presentation or sale of this manual to any individual or firm does not constitute authorization, certification or recognition of any applicable technical capabilities, or establish a principle-agent relationship of any form.

The data provided is believed to be accurate and applicable to the unit(s) indicated on the cover. The research, engineering, and service departments of YAMAHA are continually striving to improve YAMAHA products. Modifications are, therefore, inevitable and specifications are subject to change without notice or obligation to retrofit. Should any discrepancy appear to exist, please contact the distributor's Service Division.

**WARNING:** Static discharges can destroy expensive components. Discharge any static electricity your body may have accumulated by grounding yourself to the ground buss in the unit (heavy gauge black wires connect to this buss).

**IMPORTANT:** Turn the unit OFF during disassembly and part replacement. Recheck all work before you apply power to the unit.

## CONTENTS

TO SERVICE PERSONNEL .....	2-3
PREVENTION OF ELECTRO STATIC DISCHARGE .....	4
LOCALE MANAGEMENT INFORMATION .....	4
FRONT PANELS .....	5
REAR PANELS .....	5-6
REMOTE CONTROL PANEL .....	6
SPECIFICATIONS .....	7
SERVICE HINTS .....	8
DISASSEMBLY PROCEDURES .....	8-9

MAINTENANCE FLOW CHART .....	10-14
BLOCK DIAGRAM .....	15
WIRING DIAGRAM .....	16
PRINTED CIRCUIT BOARD .....	17-21
SCHEMATIC DIAGRAM .....	22-27
EXPLODED VIEW .....	28
MECHANICAL PARTS LIST .....	29



このサービスマニュアルは、エコマーク認定の再生紙を使用しています。  
This Service Manual uses recycled paper.



## ■ TO SERVICE PERSONNEL

1. Critical Components Information  
Components having special characteristics are marked  $\triangle$  and must be replaced with parts having specifications equal to those originally installed.
2. Leakage Current Measurement (For 120V Models Only)  
When service has been completed, it is imperative to verify that all exposed conductive surfaces are properly insulated from supply circuits.
  - Meter impedance should be equivalent to 1500 ohm shunted by 0.15 $\mu$ F.

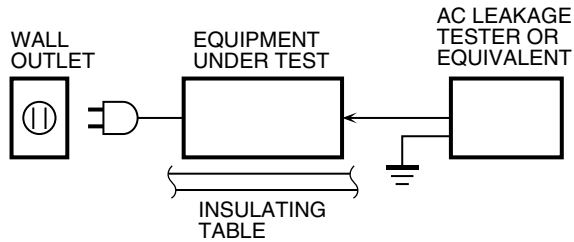

- Leakage current must not exceed 0.5mA.
- Be sure to test for leakage with the AC plug in both polarities.

## WARNING: CHEMICAL CONTENT NOTICE!

The solder used in the production of this product contains LEAD. In addition, other electrical/electronic and/or plastic (where applicable) components may also contain traces of chemicals found by the California Health and Welfare Agency (and possibly other entities) to cause cancer and/or birth defects or other reproductive harm.

DO NOT PLACE SOLDER, ELECTRICAL/ELECTRONIC OR PLASTIC COMPONENTS IN YOUR MOUTH FOR ANY REASON WHATSOEVER!

Avoid prolonged, unprotected contact between solder and your skin! When soldering, do not inhale solder fumes or expose eyes to solder/flux vapor!

If you come in contact with solder or components located inside the enclosure of this product, wash your hands before handling food.

## WARNING: Laser Safety

This product contains a laser beam component. This component may emit invisible, as well as visible radiation, which may cause eye damage. To protect your eyes and skin from laser radiation, the following precautions must be used during servicing of the unit.

- 1) When testing and/or repairing any component within the product, keep your eyes and skin more than 30 cm away from the laser pick-up unit at all times. Do not stare at the laser beam at any time.
- 2) Do not attempt to readjust, disassemble or repair the laser pick-up, unless noted elsewhere in this manual.
- 3) CAUTION : Use of controls, adjustments or performance of procedures other than those specified herein may result in hazardous radiation exposure.

## Laser Emitting conditions:

- 1) When the Top Cover is removed, and the STANDBY/ON SW is turned to the "ON" position, the laser component will emit a beam for several seconds to detect if a disc is present. During this time (5-10 sec.) the laser may radiate through the lens of the laser pick-up unit. Do not attempt any servicing during this period!  
If no disc is detected, the laser will stop emitting the beam. When a disc is loaded, you will not be exposed to any laser emissions.
- 2) The laser power level can be adjusted with the VR on the pick-up PWB, however, this level has been set by the factory prior to shipping from the factory. Do not adjust this laser level control unless instruction is provided elsewhere in this manual. Adjustment of this control can increase the laser emission level from the device.

## Laser Diode Properties

Type:	Semiconductor laser GaAlAs
Wave length:	650 nm (DVD) 780 nm (VCD/CD)
Output Power:	7 mW (DVD) 10 mW (VCD/CD)
Beam divergence:	60 degree

**VARO!** : AVATTAESSA JA SUOJALUKITUS OHITETTAESSA OLET ALTTIINA NÄKYMÄTTÖMÄLLE LASER-SÄTEILYLLE. ÄLÄ KATSO SÄTEESEEN.

**WARNING!** : OSYNLIG LASERSTRÅLNING NÄR DENNA DEL ÄR ÖPPNAD OCH SPÄRREN ÄR URKOPPLAD. BETRAKTA EJ STRÅLEN.

## WARNING

The use of optical instruments with this product will increase eye hazard.

Repair handling should take place as much as possible with a disc loaded inside the player.

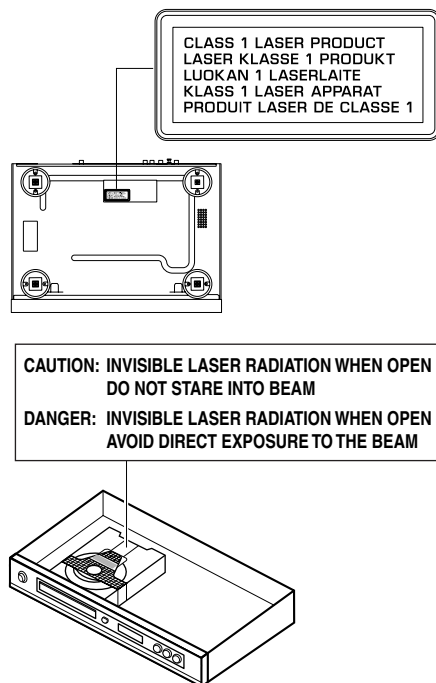

CAUTION	VISIBLE AND INVISIBLE LASER RADIATION WHEN OPEN. AVOID EXPOSURE TO BEAM.
ADVARSEL	SYNLIG OG USYNLIG LASERSTRÅLING VED ÅBNING. UNDGÅ UDSÆTTELSE FOR STRÅLING.
ADVARSEL	SYNLIG OG USYNLIG LASERSTRÅLING NÄR DEKSEL ÅPNES. UNNGÅ EKSPONERING FOR STRÅLEN.
VARNING	SYNLIG OCH OSYNLIG LASERSTRÅLNING NÄR DENNA DEL ÄR ÖPPNAD. BETRAKTA EJ STRÅLEN.
VARO!	AVATTAESSA OLET ALTTIINA NÄKYVÄLLE JA NÄKYMÄTTÖMÄLLE LASER SÄ TEILYLLE. ÄLÄ KATSO SÄTEESEEN.
VORSICHT	SICHTBARE UND UNSICHTBARE LASERSTRAHLUNG WENN ABDECKUNG GEÖFFNET. NICHT DEM STRAHL AUSSETZEN.
DANGER	VISIBLE AND INVISIBLE LASER RADIATION WHEN OPEN. AVOID DIRECT EXPOSURE TO BEAM.
ATTENTION	RAYONNEMENT LASER VISIBLE ET INVISIBLE EN CAS D'OUVERTURE. EXPOSITION DANGEREUSE AU FAISCEAU

## Warning for power supply

**The primary side of the power supply carries live mains voltage when the player is connected to the mains even when the player is switched off !**

This primary area is not shielded so it is possible to touch copper tracks and/or components when servicing the player. Service personnel have to take precautions to prevent touching this area or components in this area.

### Note:

**The screws on the DVD mechanism may never be touched, removed or re-adjusted.**

**Handle the DVD mechanism with care when the unit has to be exchanged!**

**The DVD mechanism is very sensitive for dropping or giving shocks.**

## ■ PREVENTION OF ELECTRO STATIC DISCHARGE

The laser diode in the DVD mechanism may be damaged due to static electricity from clothes or the human body. Use caution to prevent electro static damage when servicing or handling the DVD-mechanism.

### 1. Grounding for electro static damage prevention

Some devices, such as the DVD player, use an optical pickup (laser diode) that will be damaged by static electricity in the working environment. Only attempt service after ensuring that all grounding procedures have been completed.

#### 1. Worktable grounding

Put a grounded conductive material (sheet) or iron sheet on the area where the optical pickup is placed.

#### 2. Human body grounding

Use an anti-static wrist strap to discharge the static electricity from your body.

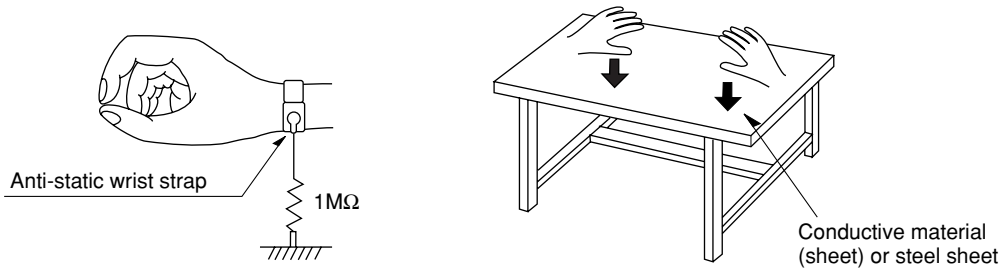

### 2. Handling Precautions for DVD mechanism

1. Handle the DVD mechanism gently, as it is an extremely high-precision assembly.
2. The flexible cable lines may break if an excessive force is applied to it. Use caution when handling the cable.
3. The semi-fixed resistor for laser power adjustment should not be adjusted. Do not turn the resistor.

## ■ LOCALE MANAGEMENT INFORMATION

Locale Management Information : This DVD player is designed and manufactured to respond to the Locale Management Information that is recorded on a DVD disc. If the Locale number described on the DVD disc does not correspond to the Locale number of this DVD player, this DVD player cannot play this disc.

This product incorporates copyright protection technology that is protected by method claims of certain U.S. patents and other intellectual property rights owned by Macrovision Corporation and other rights owners. Use of this copyright protection technology must be authorized by Macrovision Corporation, and is intended for home and other limited viewing uses only unless otherwise authorized by Macrovision Corporation. Reverse engineering or disassembly is prohibited.

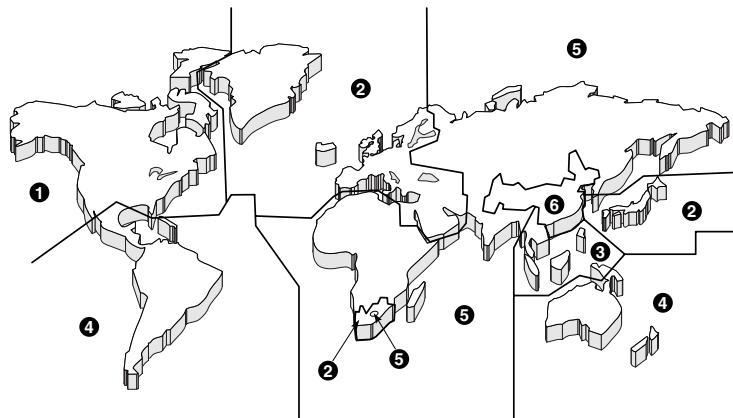

## FRONT PANELS

### ▼ DVD-S550 (U, R, K, A, B, G, E, P models)

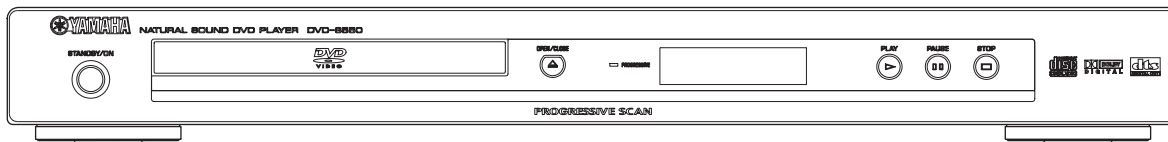

### ▼ DV-S5750 (U, A models)

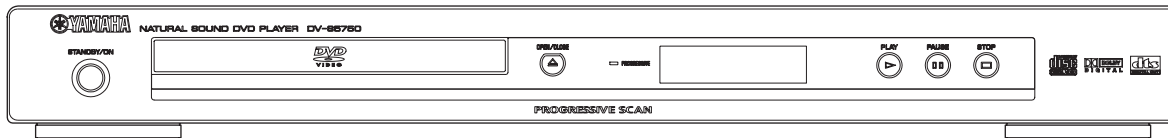

## REAR PANELS

### ▼ DVD-S550 (U model)

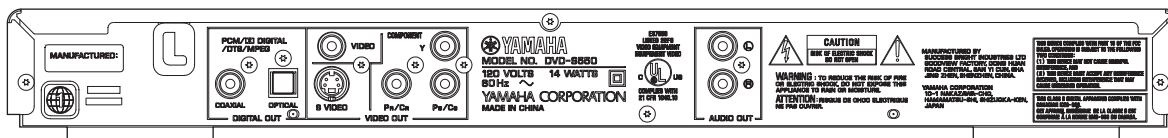

### ▼ DVD-S550 (R model)

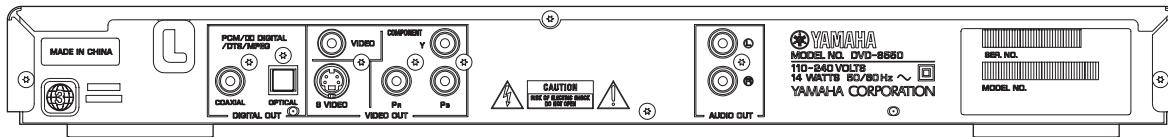

### ▼ DVD-S550 (K model)

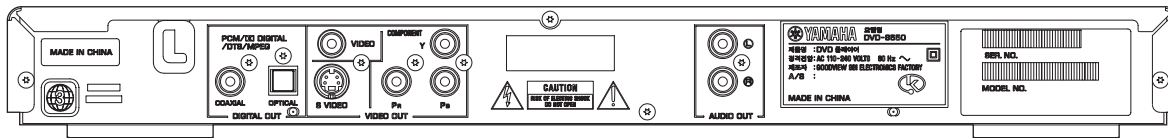

### ▼ DVD-S550 (A model)

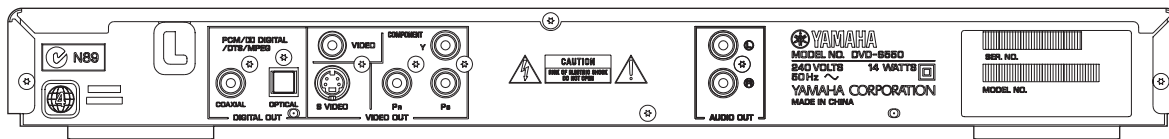

### ▼ DVD-S550 (B, G, E models)

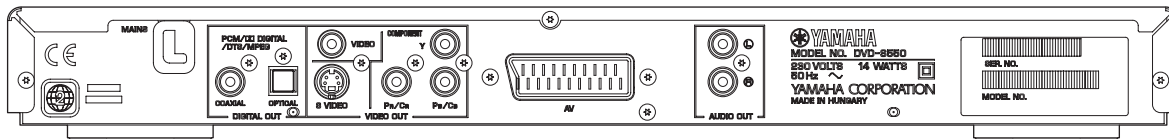

DVD-S550/DV-S5750

▼ DVD-S550 (P model)

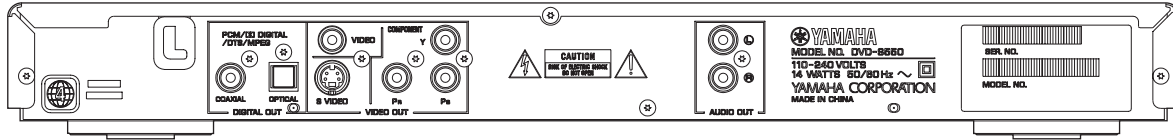

▼ DV-S5750 (U model)

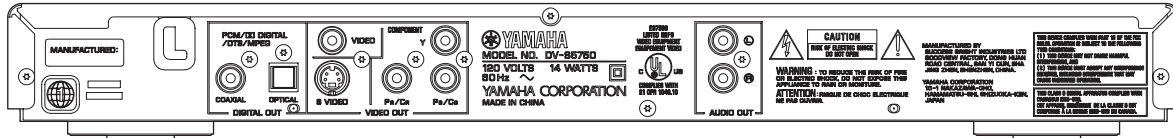

▼ DV-S5750 (A model)

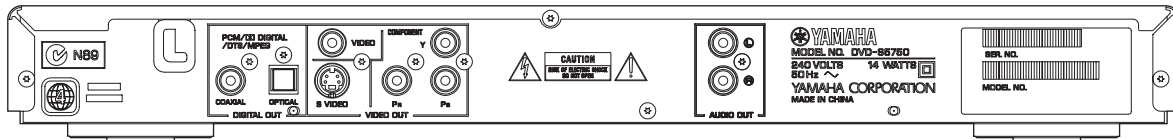

DVD-S550/DV-S5750

■ REMOTE CONTROL PANEL

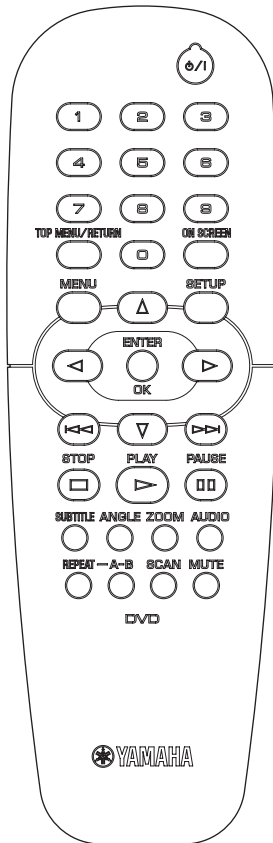

## ■ SPECIFICATIONS

### PLAYBACK SYSTEM

DVD Video  
Video CD & SVCD  
CD  
PICTURE CD  
CD-R, CD-RW  
DVD+R, DVD+RW  
DVD-R, DVD-RW

### VIDEO PERFORMANCE

Video (CVBS) Output 1 Vpp into 75 ohm  
S-Video Output Y: 1Vpp into 75 ohm  
C: 0.3Vpp into 75 ohm  
RGB (SCART) Output 0.7 Vpp into 75 ohm (B, G, E models)  
Component Video Output Y: 1Vpp into 75 ohm  
Pb/Cb Pr/Cr: 0.7Vpp into 75 ohm

### AUDIO FORMAT

Digital	Mpeg/Dolby	Compressed Digital
	Digital/DTS	
	PCM	16, 20, 24 bits
		fs, 44.1, 48, 96 kHz
	MP3(ISO 9660)	24, 32, 56, 64, 96, 128, 256 kbps
		fs 16, 22.05, 24, 32, 44.1, 48 kHz
	WMA	32 kbps-192 kbps, mono, stereo
		(U, R, K, A, P models)

Analog Sound Stereo

### AUDIO PERFORMANCE

DA Converter	24 bits
Signal-Noise (1kHz)	105 dB
Dynamic Range (1kHz)	100 dB
DVD	fs 96 kHz 2 Hz - 44 kHz
	fs 48 kHz 2 Hz - 22 kHz
SVCD	fs 48 kHz 2 Hz - 22 kHz
	fs 44.1 kHz 2 Hz - 20 kHz
CD/VCD	fs 44.1 kHz 2 Hz - 20 kHz
Distortion and Noise (1kHz)	0.003%

### TV STANDARD (PAL/50Hz) (NTSC/60Hz)

Number of lines	625	525
Playback	Multistandard	(PAL/NTSC)

### CONNECTIONS

SCART	Euroconnector (B, G, E models)
Y Output	Cinch (green)
Pb/Cb Output	Cinch (blue)
Pr/Cr Output	Cinch (red)
S-Video Output	Mini DIN, 4 pins
Video Output	Cinch
Audio Output (L+R)	Cinch
Digital Output	1 coaxial, 1 optical
	IEC60958 for CDDA / LPCM/
	MPEG1
	IEC61937 for MPEG 2,
	Dolby Digital and DTS

### GENERAL

Dimensions (W x H x D)	435 x 51 x 310 mm (17-1/8" x 2" x 12-3/16")
Weight	Approx. 2.6 Kg (5 lbs. 12 oz)
Finish	[DVD-S550] Gold Color (R, K models) Black Color (U, A, B, G, E, P models) Titanium Color (U, G, E models) Silver Color (B, G, E models)
	[DV-S5750] Black Color (U model) Silver Color (U, A models)
Power Supply	AC120V, 60 Hz (U model) AC240V, 50 Hz (A model) AC110-240V, 50/60 Hz (R, K, P models) AC230V, 50 Hz (B, G, E models)
Power Consumption	Approx. 14W
Standby Power Consumption	< 1W

### ACCESSORIES

Remote Control x 1, Battery x 2,  
Audio/Video Cable (U, R, K, A, P models),  
Audio Pin Cable (B, G, E models),  
Video Cable (B, G, E models)

\* *Specifications subject to change without prior notice.*

<i>U</i> .....	<i>U.S.A model</i>	<i>R</i> .....	<i>General model</i>
<i>K</i> .....	<i>Korean model</i>	<i>A</i> .....	<i>Australian model</i>
<i>B</i> .....	<i>British model</i>	<i>G</i> .....	<i>European model</i>
<i>E</i> .....	<i>South European model</i>	<i>P</i> .....	<i>South American model</i>



Manufactured under license from Dolby Laboratories.  
"Dolby" and the double-D symbol are trademarks of Dolby Laboratories.



"DTS" and "DTS Digital Out" are trademarks of Digital Theater Systems, Inc.



DivX, DivX Certified, and associated logos are trademarks of DivXNetworks, Inc and are used under license.

This product incorporates copyright protection technology that is protected by method claims of certain U.S. patents and other intellectual property rights owned by Macrovision Corporation and other rights owners. Use of this copyright protection technology must be authorized by Macrovision Corporation, and is intended for home and other limited viewing uses only unless otherwise authorized by Macrovision Corporation. Reverse engineering or disassembly is prohibited.

## ■ SERVICE HINTS

### ● Repair Tips

#### 1) DVD Module

The DVD Mechanism and Mono Board together as a set are called the DVD Module.

If a failure has occurred with any part of the DVD Module, be sure to replace the DVD Module as a whole.

Neither the DVD Mechanism nor Mono Board can be replaced independently.

#### 2) Power Supply Unit

The power supply unit has to be replaced in case of failure.

#### 3) PCB Ass'y

When the Front Board or AV Board has failed, replace the faulty board.

## ■ DISASSEMBLY PROCEDURES

### HOW TO MANUALLY EJECT THE TRAY

- a. Turn the player bottom up.
- b. Move the slider in the direction indicated with a screw driver until the tray is ejected.
- c. Gently pull the tray out.

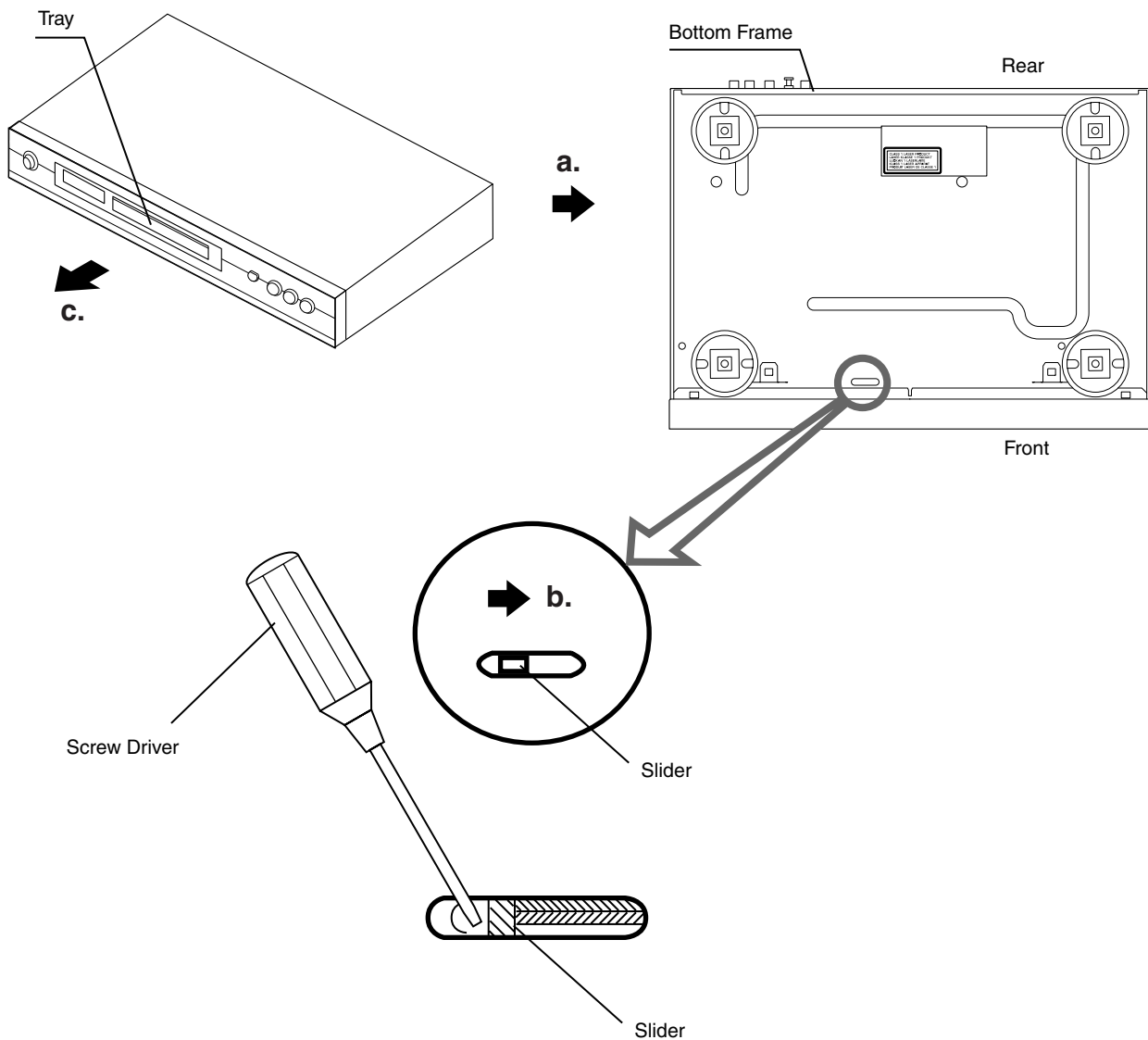

DVD-S550/DV-S5750



See EXPLODED VIEW for item numbers.

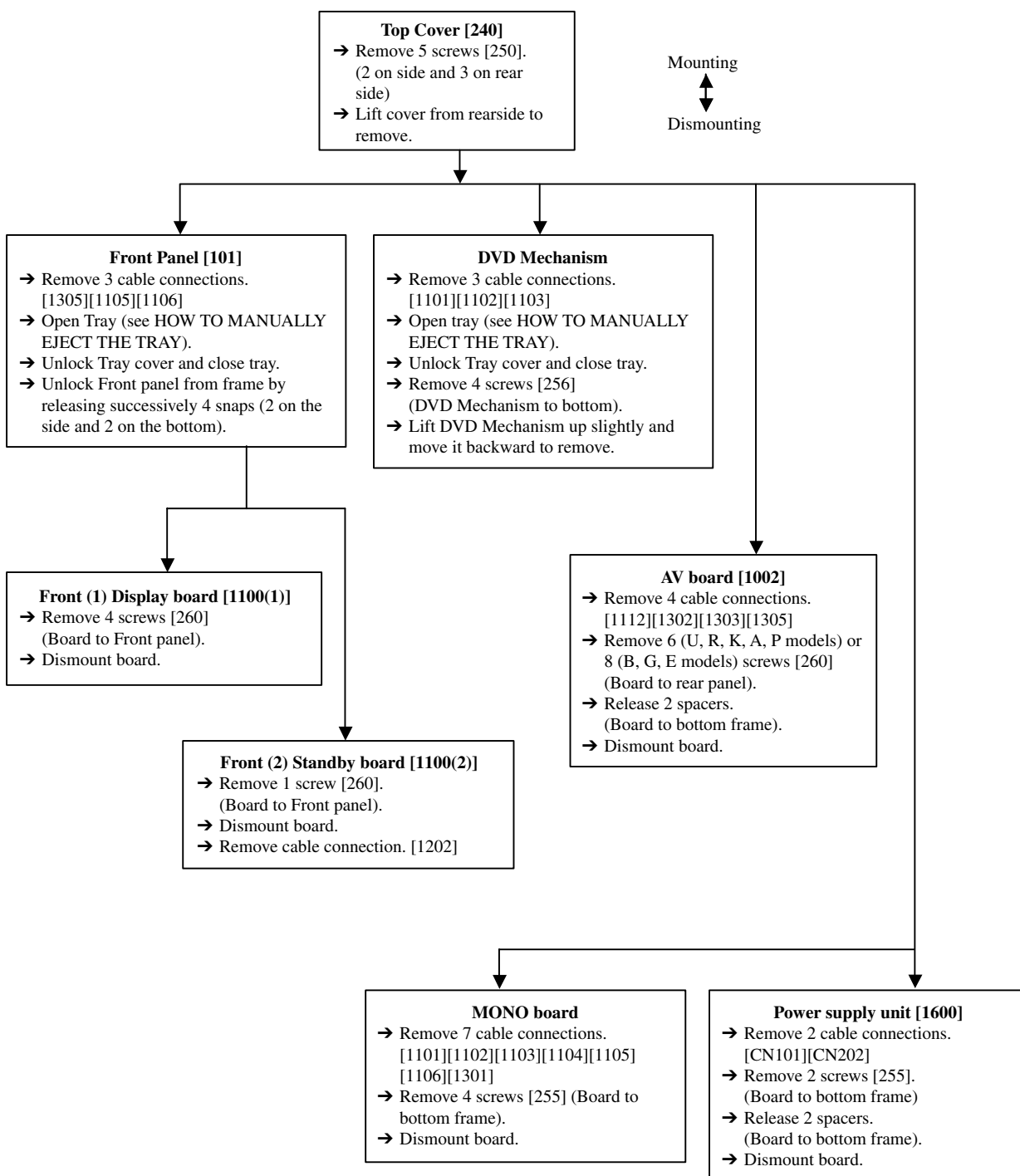

When disassembling, use the special screw driver with such tip shape as shown in figure.

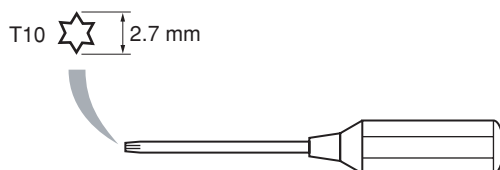

## MAINTENANCE FLOW CHART

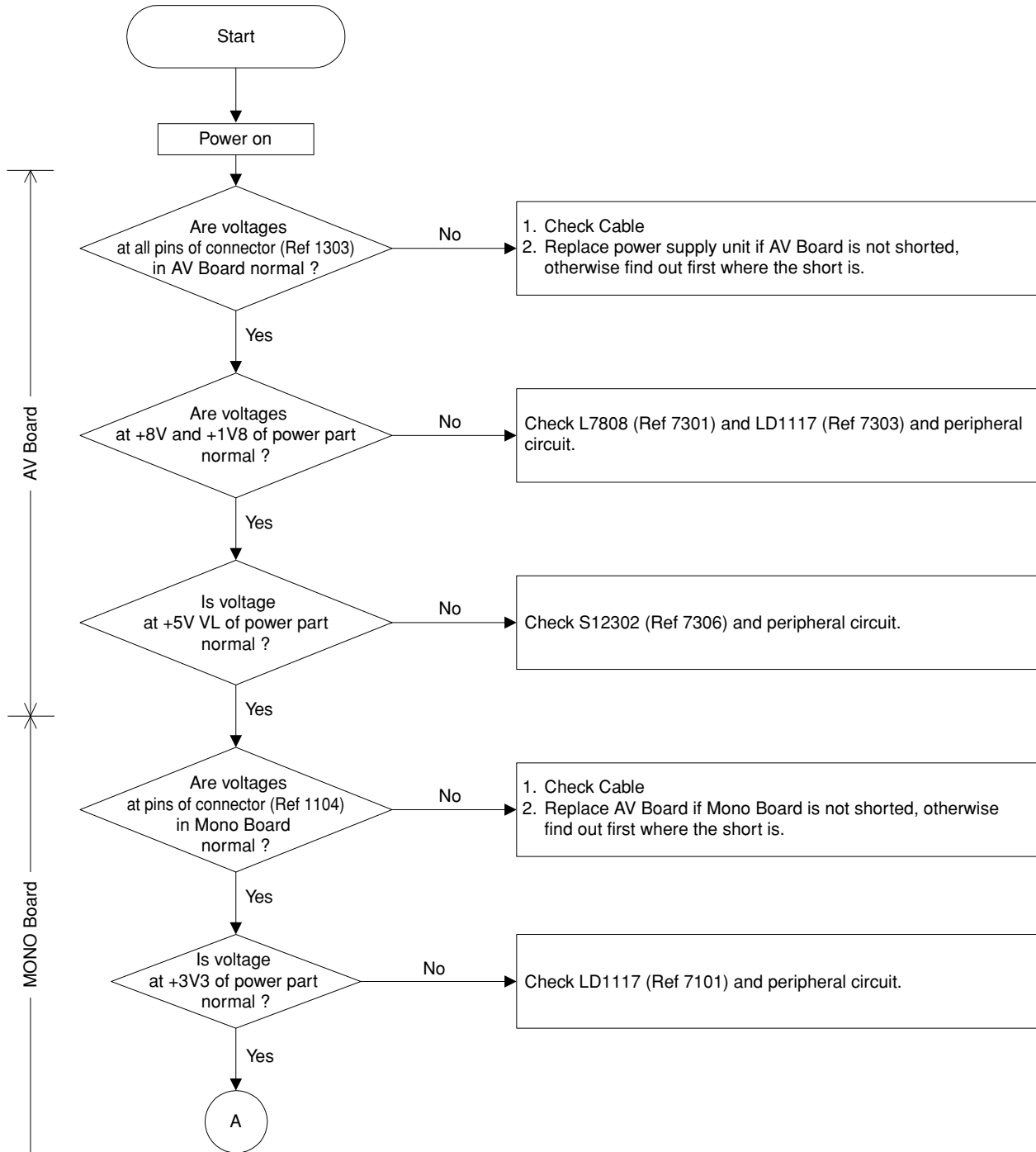

DVD-S550/DV-S5750

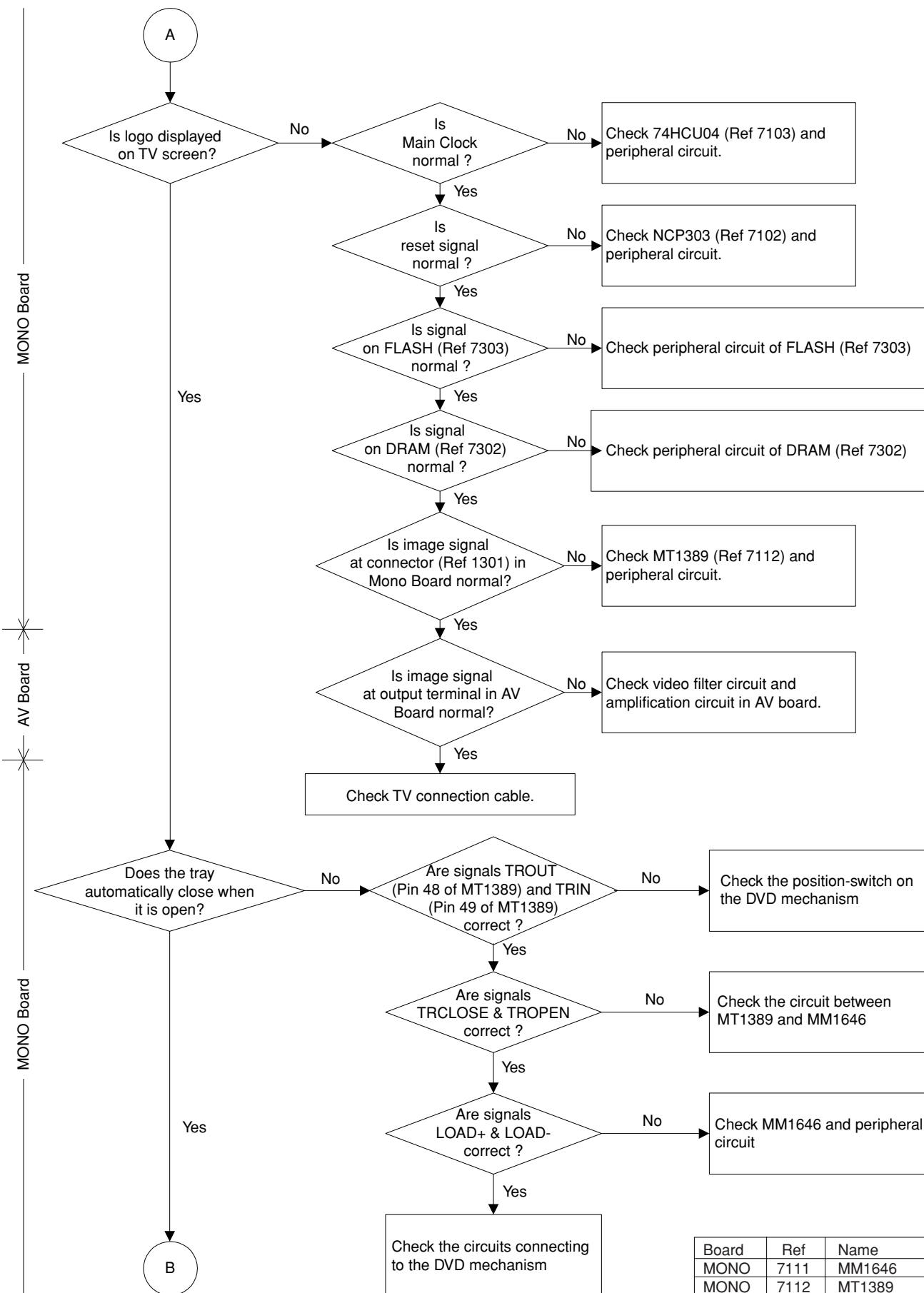

DVD-S550/DV-S5750

Board	Ref	Name
MONO	7111	MM1646
MONO	7112	MT1389

MONO Board

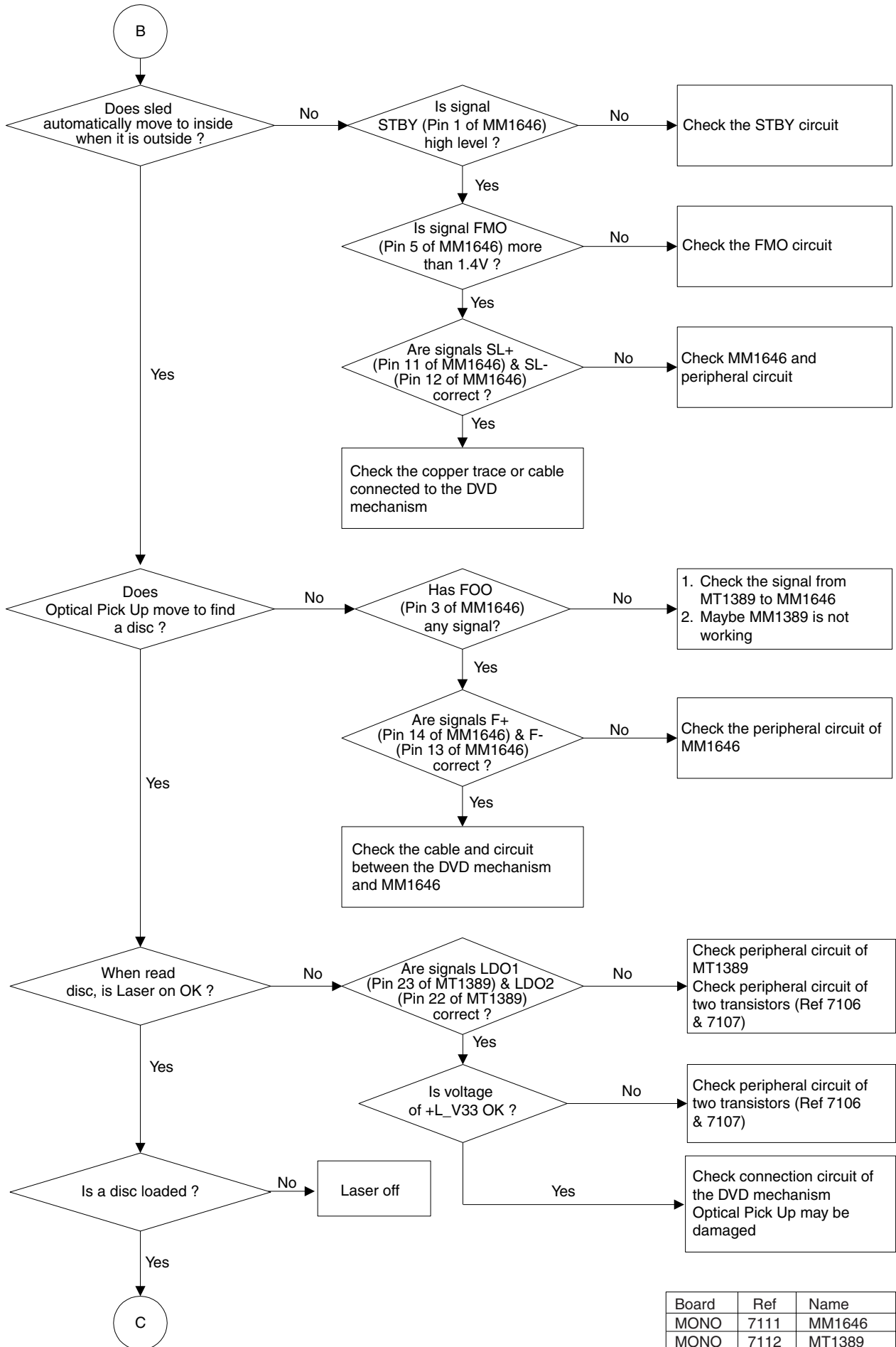

Board	Ref	Name
MONO	7111	MM1646
MONO	7112	MT1389

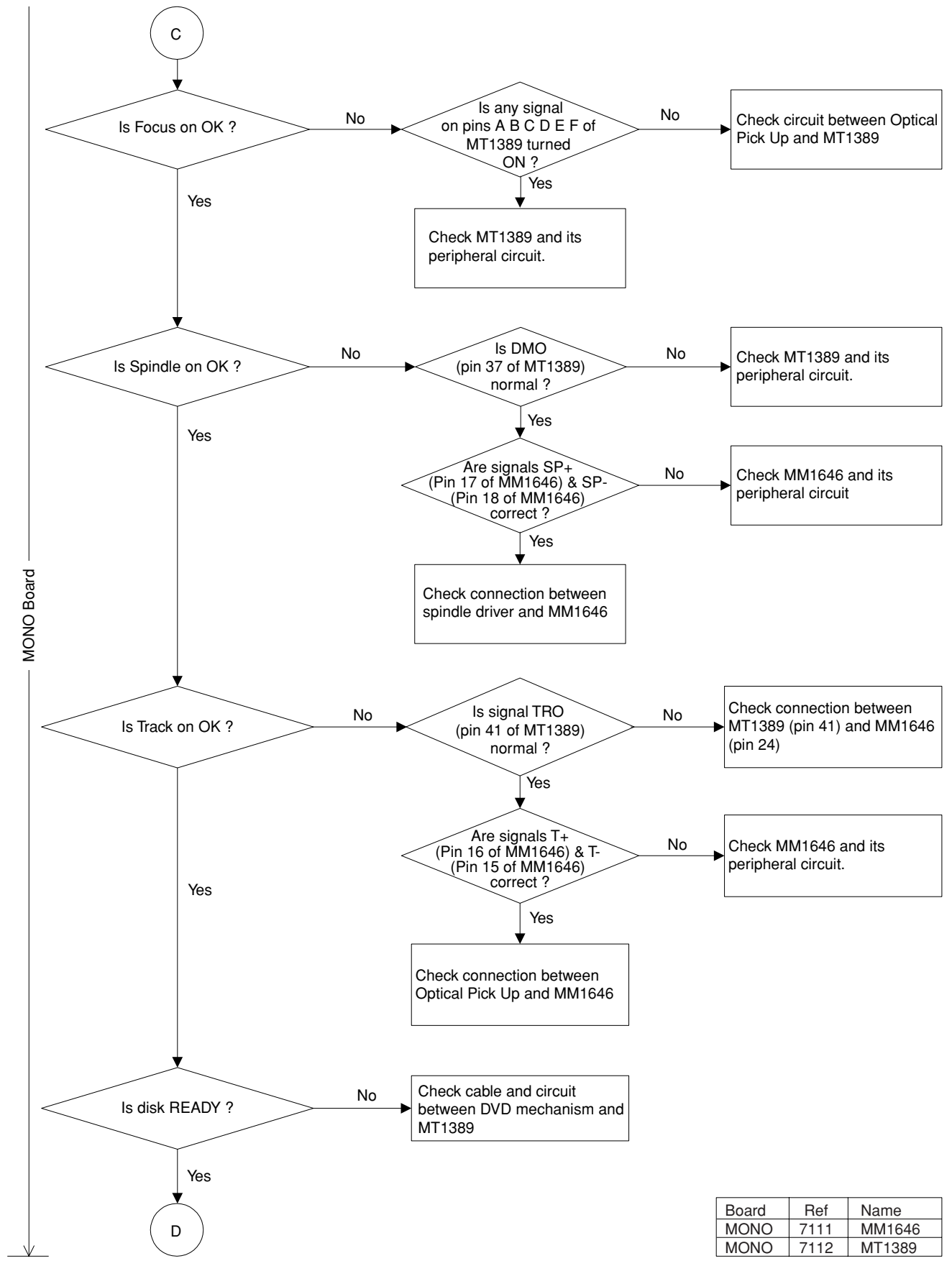

Board	Ref	Name
MONO	7111	MM1646
MONO	7112	MT1389

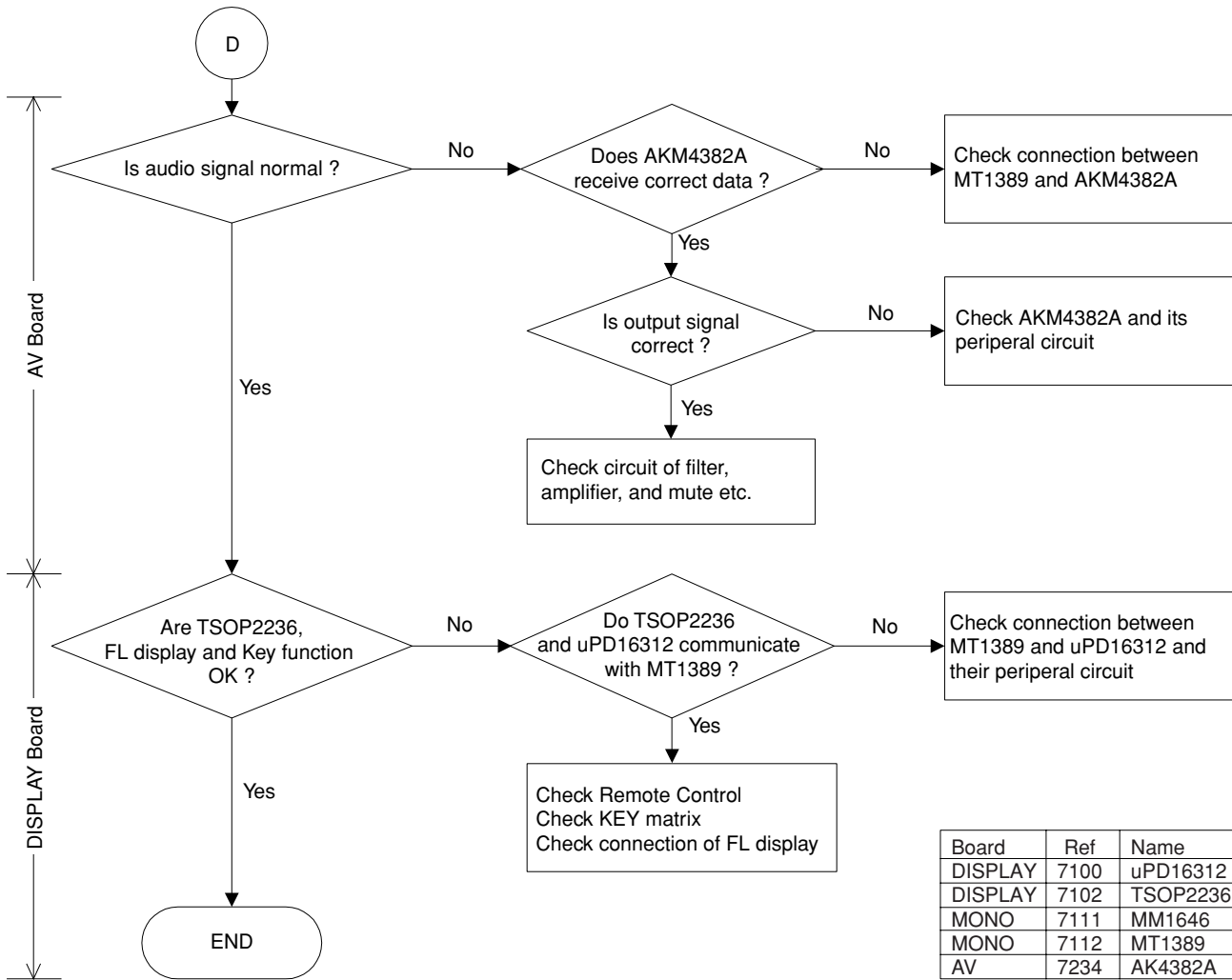

Board	Ref	Name
DISPLAY	7100	uPD16312
DISPLAY	7102	TSOP2236
MONO	7111	MM1646
MONO	7112	MT1389
AV	7234	AK4382A

**■ BLOCK DIAGRAM**

1  
2  
3  
4  
5  
6

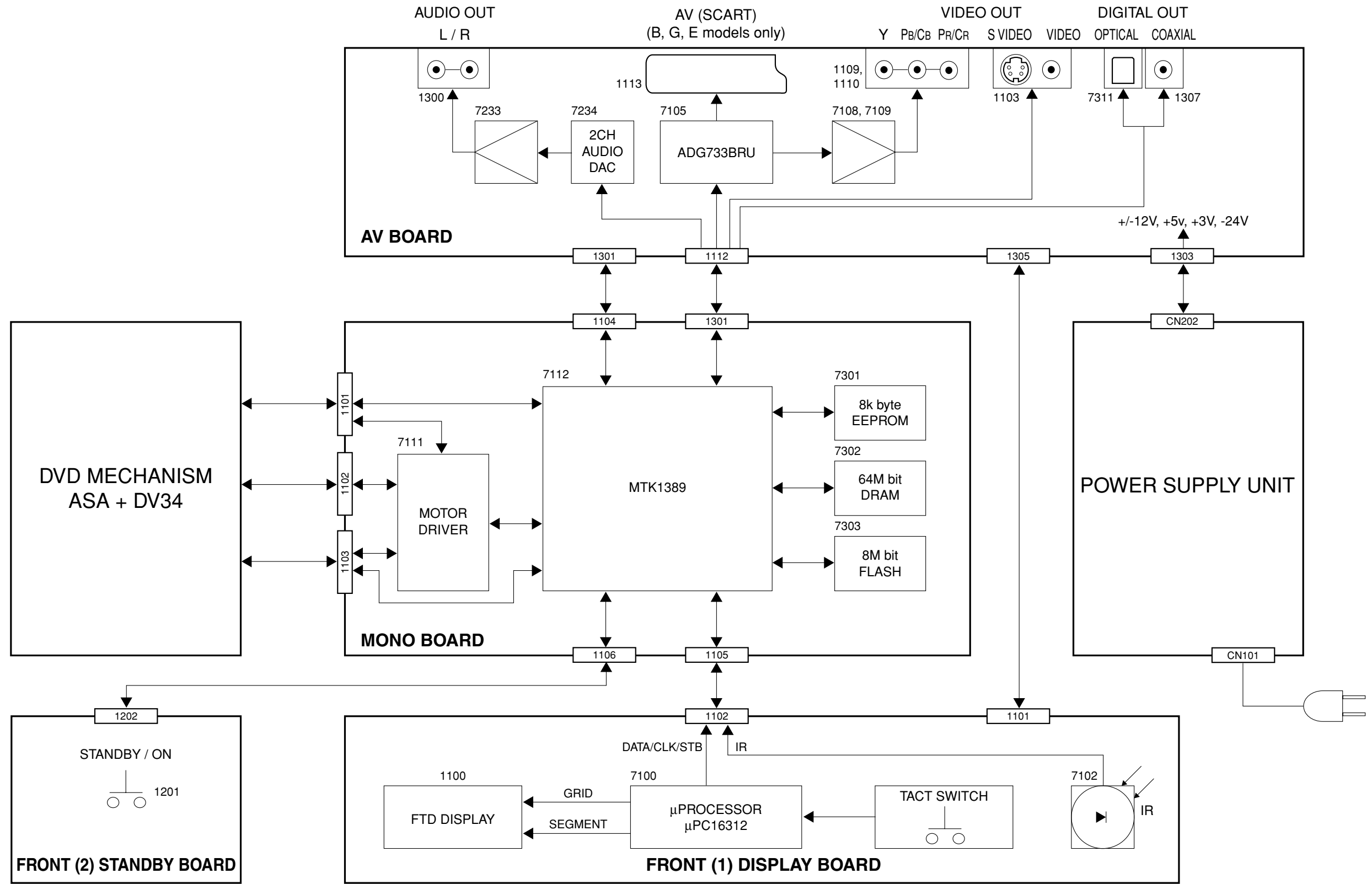

WIRING DIAGRAM

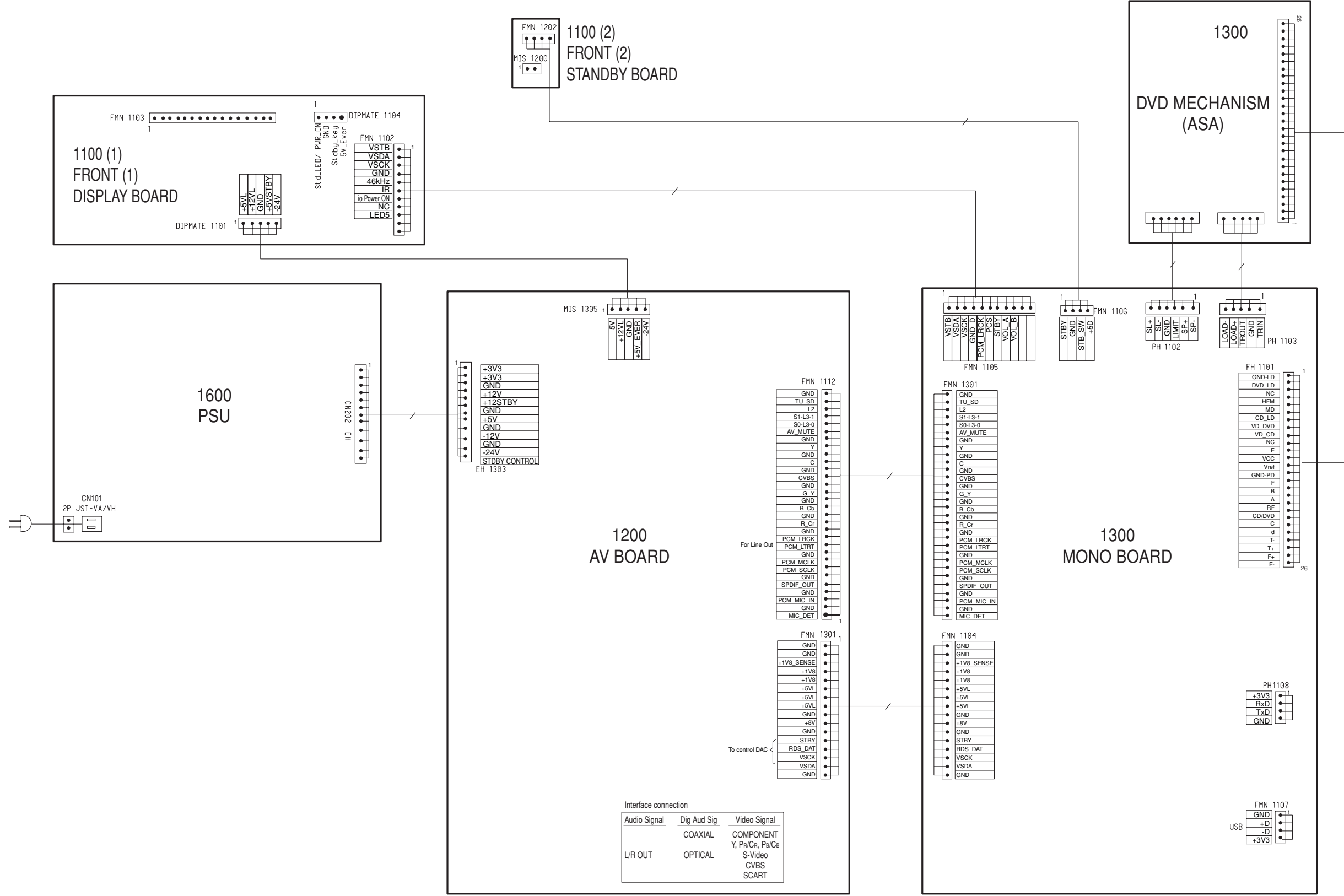



**PRINTED CIRCUIT BOARD**  
 FOR INFORMATION ONLY (NO SERVICE PARTS WILL BE AVAILABLE)

MONO Board-Top View

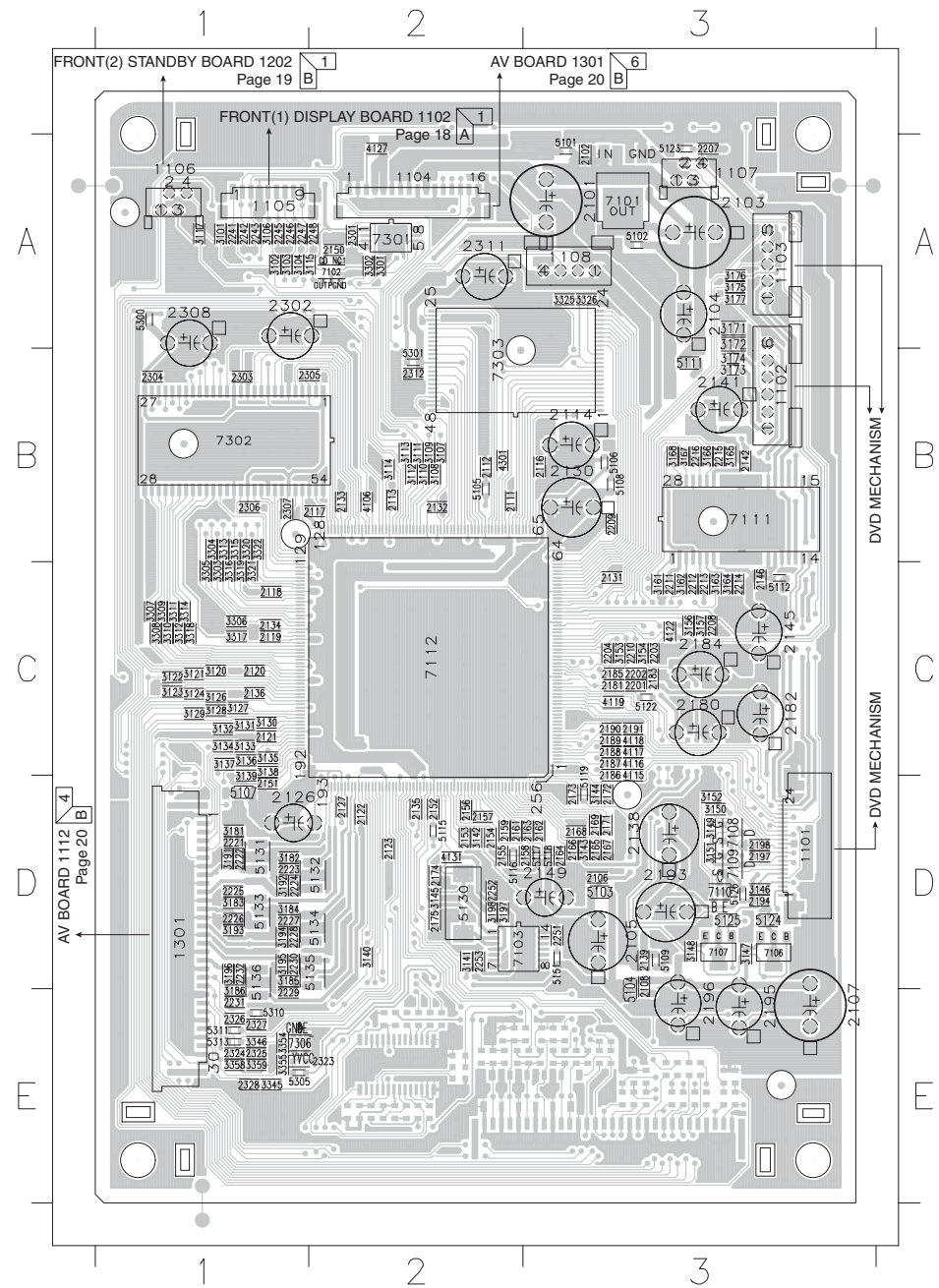

1101	D3	2173	D3	2312	B2	3171	A3	5105	B2
1102	B3	2174	D2	2323	E1	3172	A3	5106	B3
1103	A3	2175	D2	2324	E1	3173	B3	5107	D1
1104	A2	2180	C3	2325	E1	3174	B3	5108	B3
1105	A1	2181	C3	2326	E1	3175	A3	5109	D3
1106	A1	2182	C3	2327	E1	3176	A3	5111	B3
1107	A3	2183	C3	2328	E1	3177	A3	5112	C3
1108	A3	2184	C3	3101	A1	3181	D1	5115	D2
1301	D1	2185	C3	3102	A1	3182	D1	5116	D2
2101	A3	2186	C3	3103	A1	3183	D1	5117	D3
2102	A3	2187	C3	3104	A1	3184	D1	5118	D3
2103	A3	2188	C3	3106	A1	3185	D1	5119	D3
2104	A3	2189	C3	3107	B2	3186	E1	5122	C3
2105	D3	2190	C3	3108	B2	3191	D1	5123	A3
2106	D3	2191	C3	3109	B2	3192	D1	5124	D3
2107	E3	2193	D3	3110	B2	3193	D1	5125	D3
2108	D3	2194	D3	3111	B2	3194	D1	5126	D3
2111	B2	2195	E3	3112	B2	3195	D1	5130	D2
2112	B2	2196	E3	3113	B2	3196	D1	5131	D1
2113	B2	2197	D3	3114	B2	3197	D2	5132	D2
2114	B3	2198	D3	3115	A2	3198	D2	5133	D1
2116	B3	2201	C3	3117	A1	3301	A2	5134	D2
2117	B2	2202	C3	3120	C1	3302	A2	5135	D2
2118	C1	2203	C3	3121	C1	3303	C1	5136	D1
2119	C1	2204	C3	3122	C1	3304	B1	5151	D3
2120	C1	2207	A3	3123	C1	3305	C1	5300	A1
2121	C1	2208	C3	3124	C1	3306	C1	5301	B2
2122	D2	2209	B3	3126	C1	3307	C1	5305	E1
2123	D2	2210	C3	3127	C1	3308	C1	5310	E1
2126	D1	2211	C3	3128	C1	3309	C1	5311	E1
2127	D2	2212	C3	3129	C1	3310	C1	5313	E1
2130	B3	2213	C3	3130	C1	3311	C1	7101	A3
2131	C3	2214	C3	3131	C1	3312	C1	7102	A2
2132	B2	2215	B3	3132	C1	3313	B1	7103	D2
2133	B2	2216	B3	3133	C1	3314	C1	7106	D3
2134	C1	2221	D1	3134	C1	3315	B1	7107	D3
2135	D2	2222	D1	3135	C1	3316	C1	7108	D3
2136	C1	2223	D1	3136	C1	3317	C1	7109	D3
2138	D3	2224	D1	3137	C1	3318	C1	7110	D3
2139	D3	2225	D1	3138	C1	3319	C1	7111	B3
2141	B3	2226	D1	3139	D1	3320	B1	7112	C2
2142	B3	2227	D1	3140	D2	3321	C1	7301	A2
2145	C3	2228	D1	3141	D2	3322	B1	7302	B1
2146	C3	2229	E1	3142	D2	3325	A3	7303	B2
2149	D3	2230	D1	3143	D3	3326	A3	7306	E1
2150	A2	2231	E1	3144	D3	3345	E1		
2151	D1	2232	D1	3145	D2	3346	E1		
2152	D2	2241	A1	3146	D3	3354	E1		
2153	D2	2242	A1	3147	D3	3355	E1		
2154	D2	2243	A1	3148	D3	3358	E1		
2155	D2	2245	A1	3149	D3	3359	E1		
2156	D2	2246	A1	3150	D3	3386	F3		
2157	D2	2247	A1	3151	D3	4106	B2		
2158	D3	2248	A2	3152	D3	4115	C3		
2159	D2	2251	D3	3153	C3	4116	C3		
2161	D2	2252	D2	3154	C3	4117	C3		
2162	D3	2253	D2	3156	C3	4118	C3		
2163	D3	2301	A2	3157	C3	4119	C3		
2164	D3	2302	A1	3161	C3	4122	C3		
2165	D3	2303	B1	3162	C3	4127	A2		
2166	D3	2304	B1	3163	C3	4131	D2		
2167	D3	2305	B2	3164	C3	4301	B2		
2168	D3	2306	B1	3165	B3	5101	A3		
2169	D3	2307	B1	3166	B3	5102	A3		
2171	D3	2308	A1	3167	B3	5103	D3		
2172	D3	2311	A2	3168	B3	5104	E3		

The first digit of a component indicates the component type.

- 1xxx : Connector    3xxx : Resistor    5xxx : Coil    7xxx : IC, Transistor, FET  
 2xxx : Capacitor    4xxx : SMD jumper    6xxx : Diode    9xxx : Wire jumper

MONO Board-Bottom View

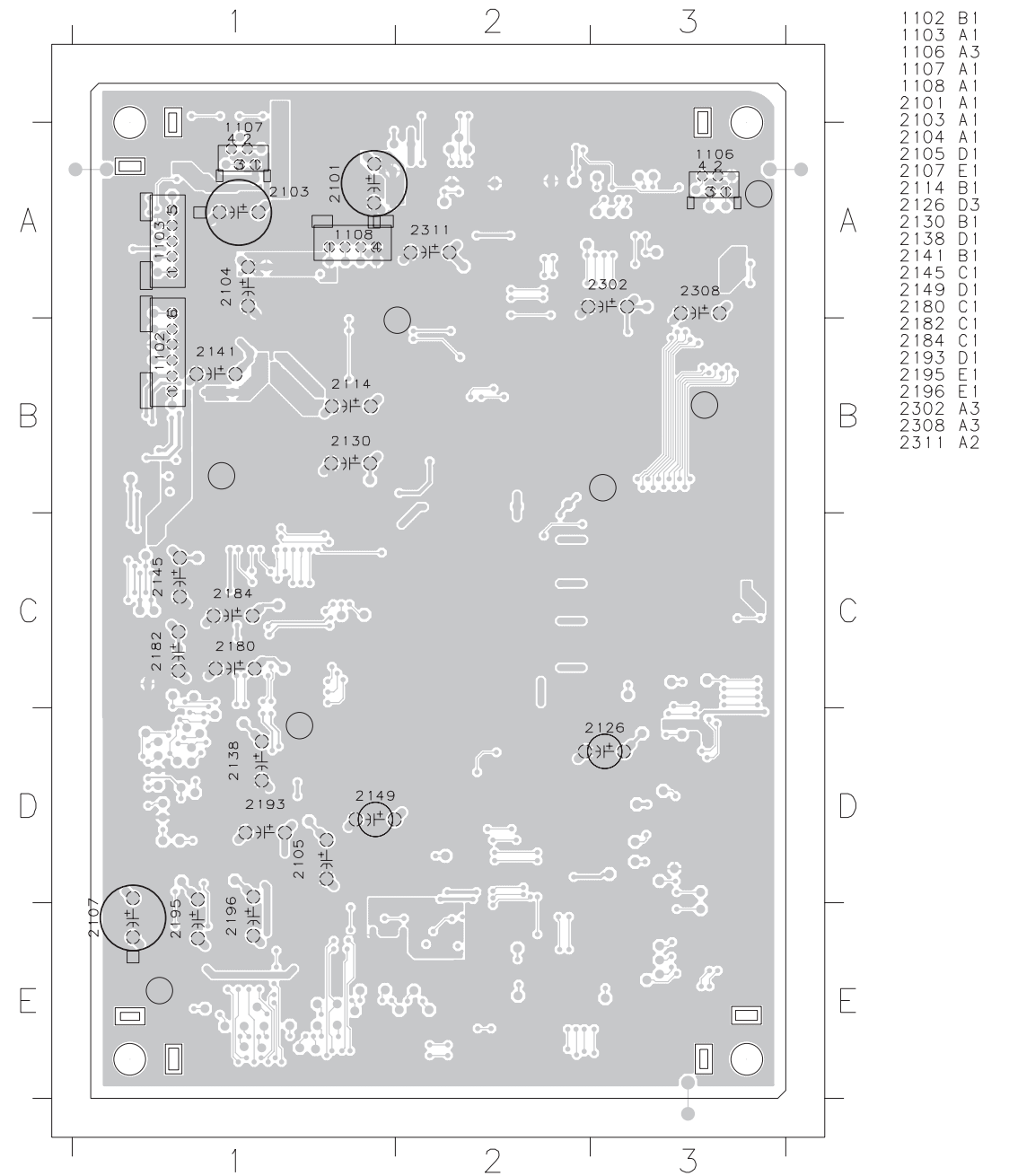

■ PRINTED CIRCUIT BOARD

FOR INFORMATION ONLY (NO SERVICE PARTS WILL BE AVAILABLE)

The first digit of a component indicates the component type.

1xxx : Connector    3xxx : Resistor    5xxx : Coil    7xxx : IC, Transistor, FET  
 2xxx : Capacitor    4xxx : SMD jumper    6xxx : Diode    9xxx : Wire jumper

FRONT (1) Display Board-Top View

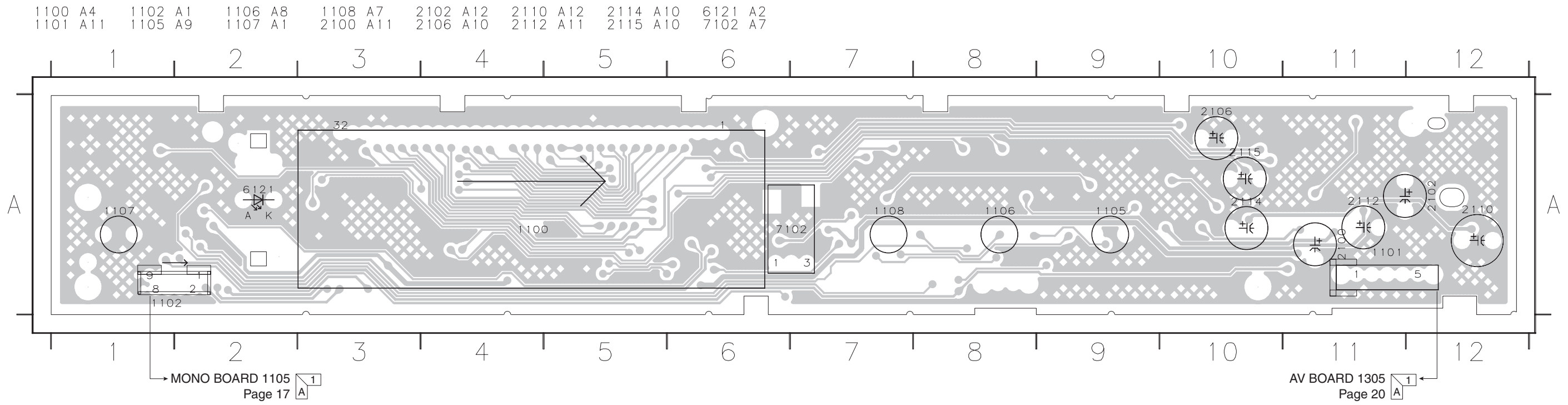

FRONT (1) Display Board-Bottom View

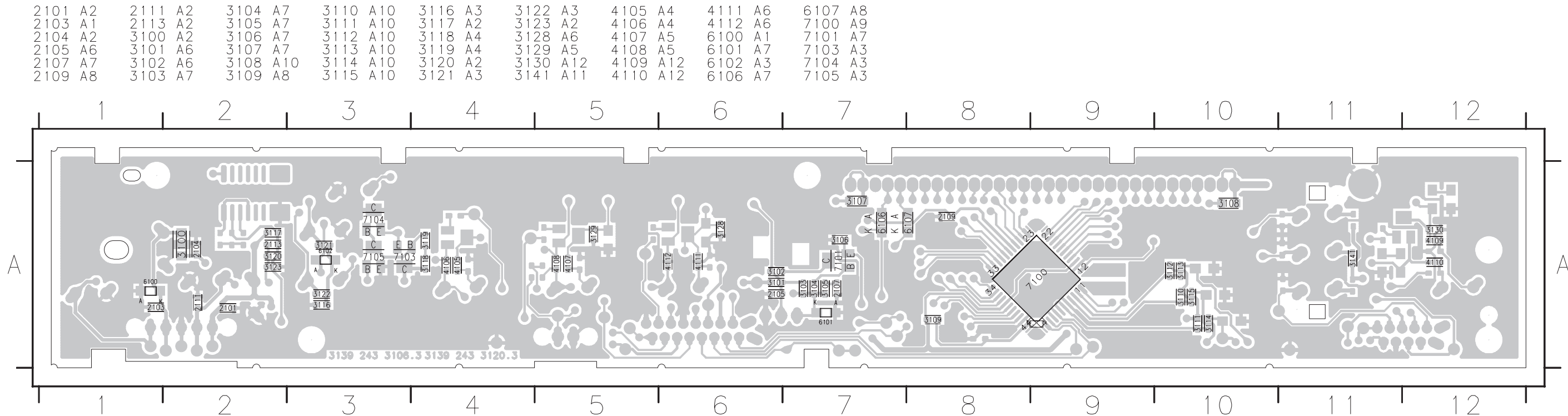

■ PRINTED CIRCUIT BOARD

FOR INFORMATION ONLY (NO SERVICE PARTS WILL BE AVAILABLE)

The first digit of a component indicates the component type.

- 1xxx : Connector    3xxx : Resistor    5xxx : Coil    7xxx : IC, Transistor, FET
- 2xxx : Capacitor    4xxx : SMD jumper    6xxx : Diode    9xxx : Wire jumper

FRONT (2) Standby Board-Top View

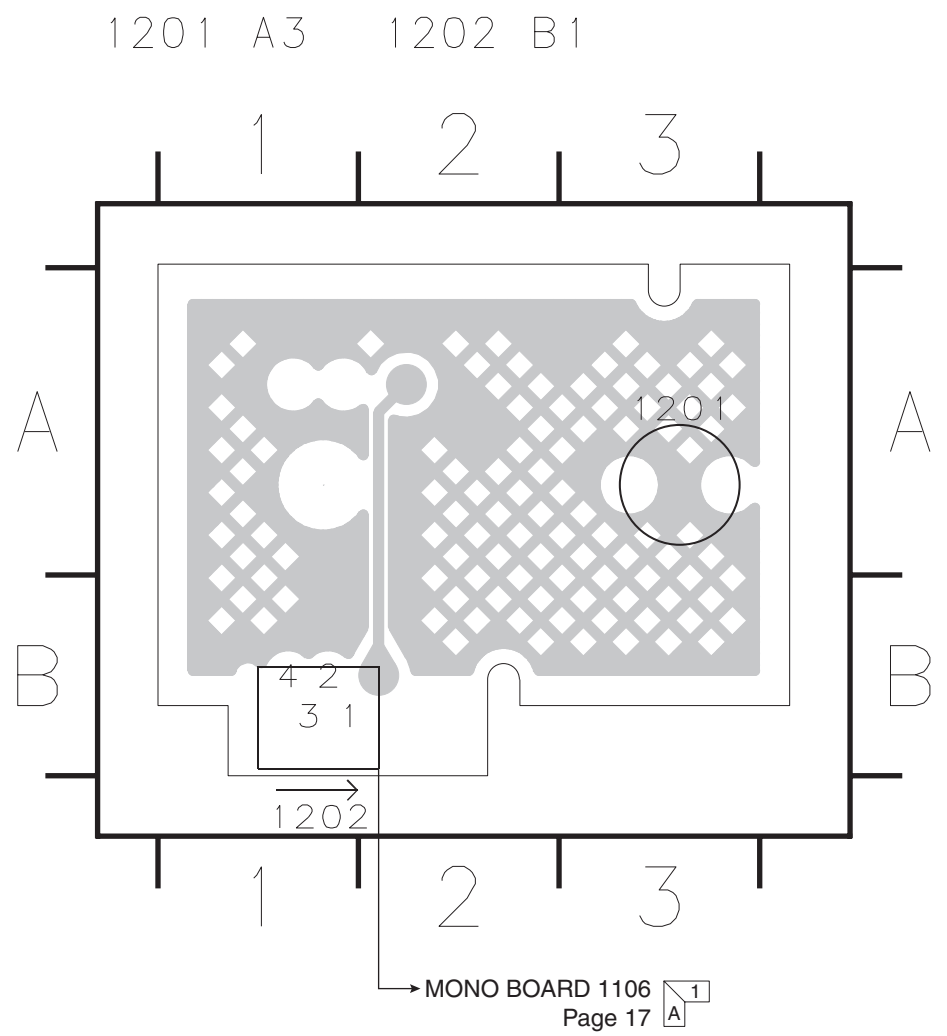

FRONT (2) Standby Board-Bottom View

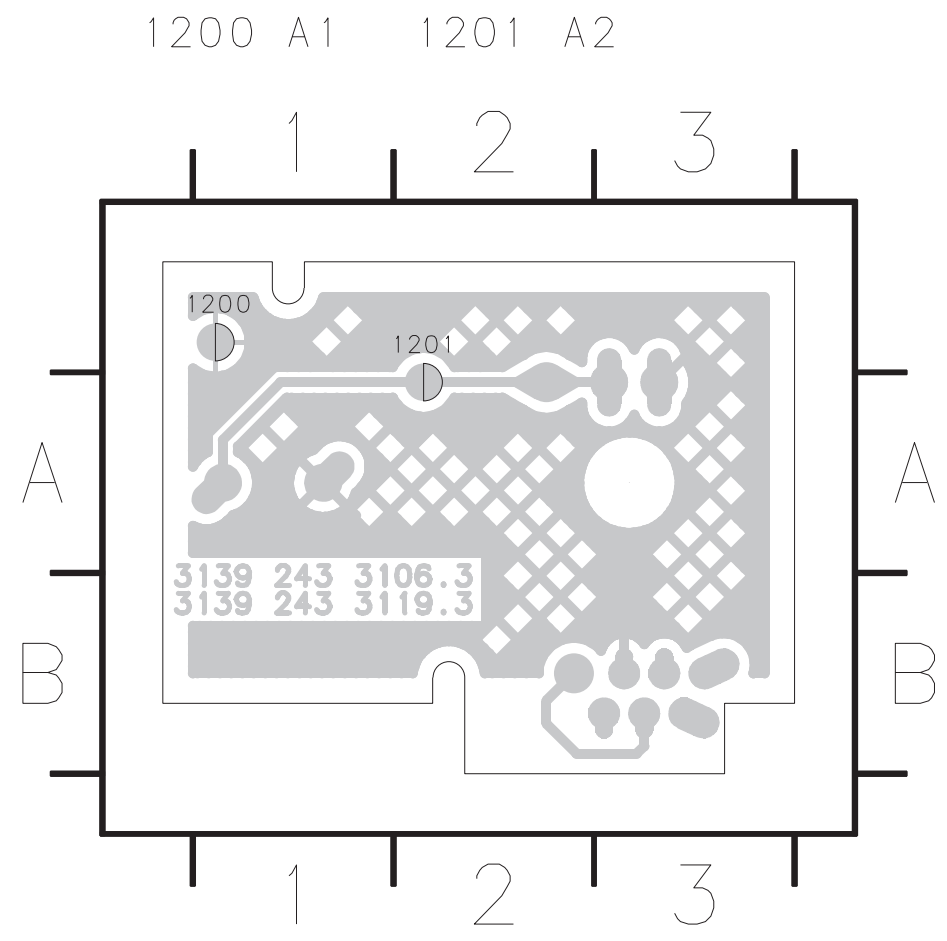



**PRINTED CIRCUIT BOARD**  
 FOR INFORMATION ONLY (NO SERVICE PARTS WILL BE AVAILABLE)

**AV Board-Bottom View**

The first digit of a component indicates the component type.

- 1xxx : Connector      3xxx : Resistor      5xxx : Coil      7xxx : IC, Transistor, FET
- 2xxx : Capacitor    4xxx : SMD jumper    6xxx : Diode    9xxx : Wire jumper

- |       |      |       |      |       |      |       |      |      |    |      |    |      |     |      |    |      |    |      |     |      |     |      |     |      |     |      |     |      |    |
|-------|------|-------|------|-------|------|-------|------|------|----|------|----|------|-----|------|----|------|----|------|-----|------|-----|------|-----|------|-----|------|-----|------|----|
| T1101 | B112 | T1107 | B113 | T1113 | A114 | T1201 | B114 | T127 | G6 | T133 | G8 | T140 | F10 | T201 | B7 | T207 | C9 | T213 | C2  | T305 | B11 | T311 | D16 | T317 | B11 | T323 | B15 | T329 | C1 |
| T1102 | B119 | T1109 | B113 | T1114 | A110 | T1202 | B14  | T128 | G6 | T134 | G8 | T141 | F10 | T202 | B7 | T208 | C9 | T216 | C6  | T306 | B11 | T312 | D16 | T318 | B11 | T324 | B15 | T330 | C1 |
| T1103 | B12  | T1110 | B13  | T1115 | A110 | T1203 | B14  | T129 | G6 | T135 | G8 | T142 | F10 | T203 | B7 | T209 | C9 | T217 | C4  | T307 | B11 | T313 | D16 | T319 | B11 | T325 | B15 | T331 | C1 |
| T1104 | B13  | T1111 | B14  | T1116 | A112 | T1204 | B13  | T130 | G6 | T136 | G8 | T143 | F10 | T204 | B7 | T210 | C9 | T218 | B11 | T308 | B11 | T314 | D16 | T320 | B15 | T326 | B15 | T332 | C1 |
| T1105 | B13  | T1112 | B14  | T1117 | A114 | T1205 | B13  | T131 | G6 | T137 | G8 | T144 | F10 | T205 | B7 | T211 | C9 | T219 | B11 | T309 | B11 | T315 | D16 | T321 | B15 | T327 | B15 | T333 | C1 |
| T1106 | B13  | T1118 | B14  | T1119 | A114 | T1206 | B8   | T132 | G8 | T138 | G8 | T145 | B14 | T206 | B8 | T212 | B6 | T220 | B14 | T310 | C11 | T316 | D16 | T322 | B15 | T328 | B16 | T333 | F3 |

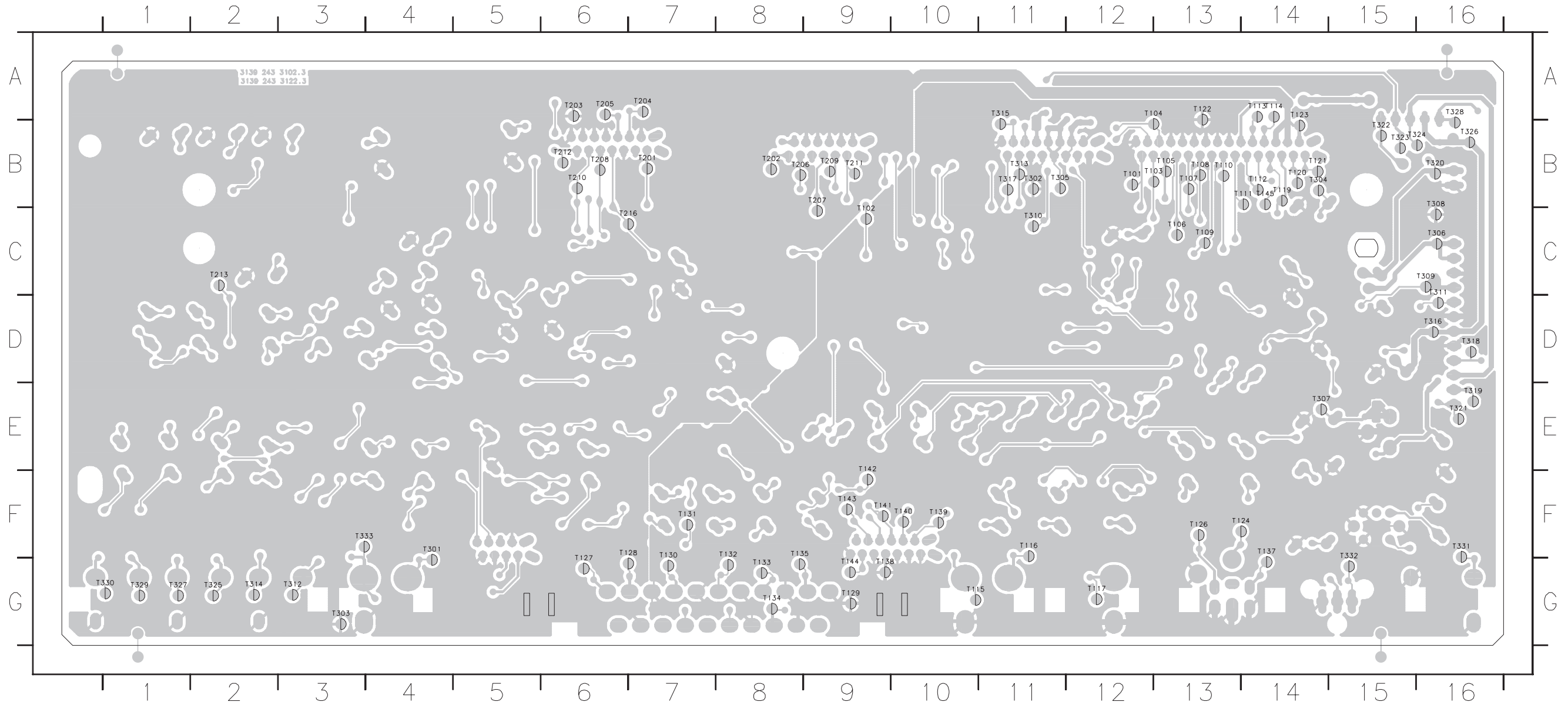

# SCHEMATIC DIAGRAM

FOR INFORMATION ONLY (NO SERVICE PARTS WILL BE AVAILABLE)

The first digit of a component indicates the component type.

1xxx : Connector    3xxx : Resistor    5xxx : Coil    7xxx : IC, Transistor, FET

2xxx : Capacitor    4xxx : SMD jumper    6xxx : Diode    9xxx : Wire jumper

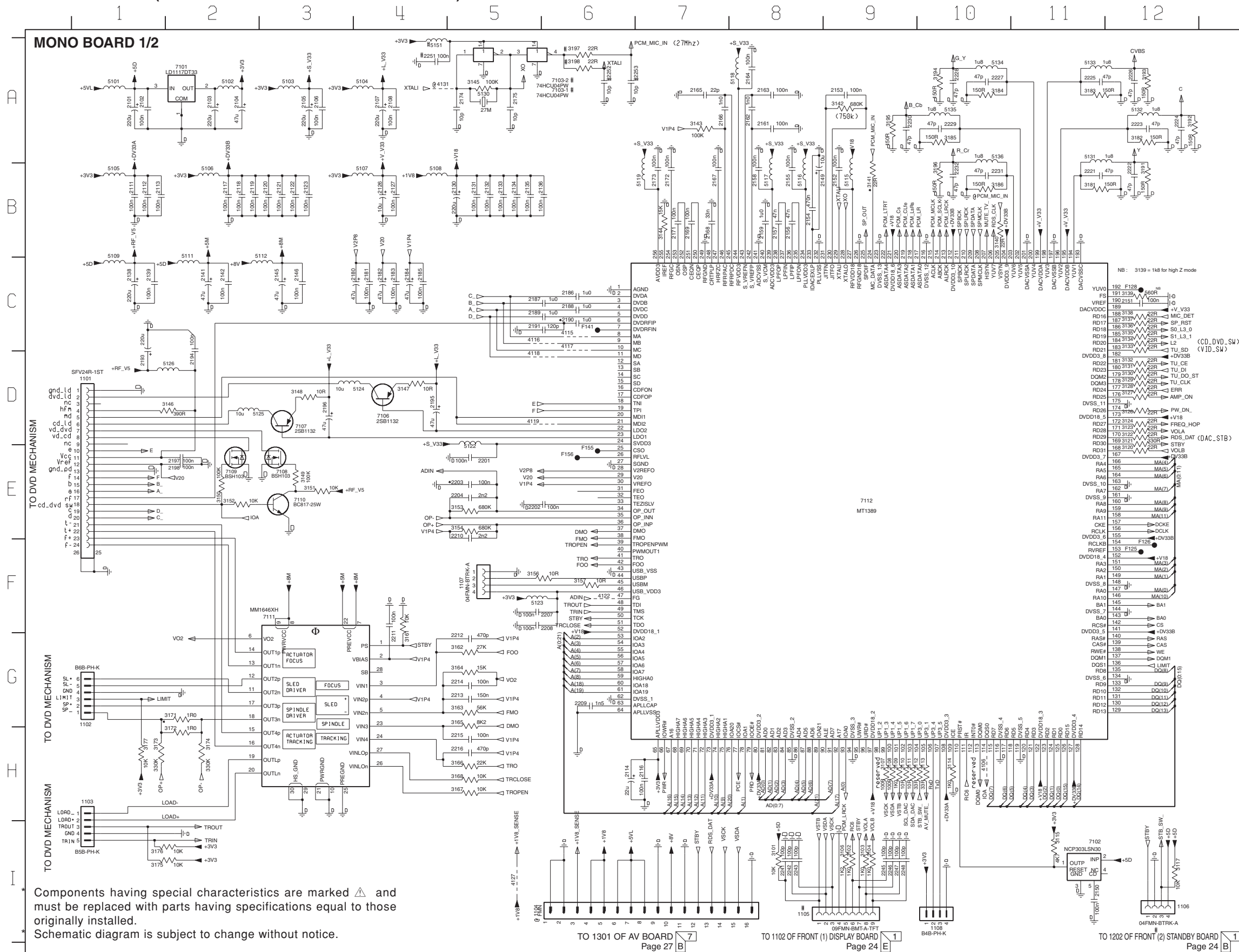

Components having special characteristics are marked  $\Delta$  and must be replaced with parts having specifications equal to those originally installed.  
Schematic diagram is subject to change without notice.

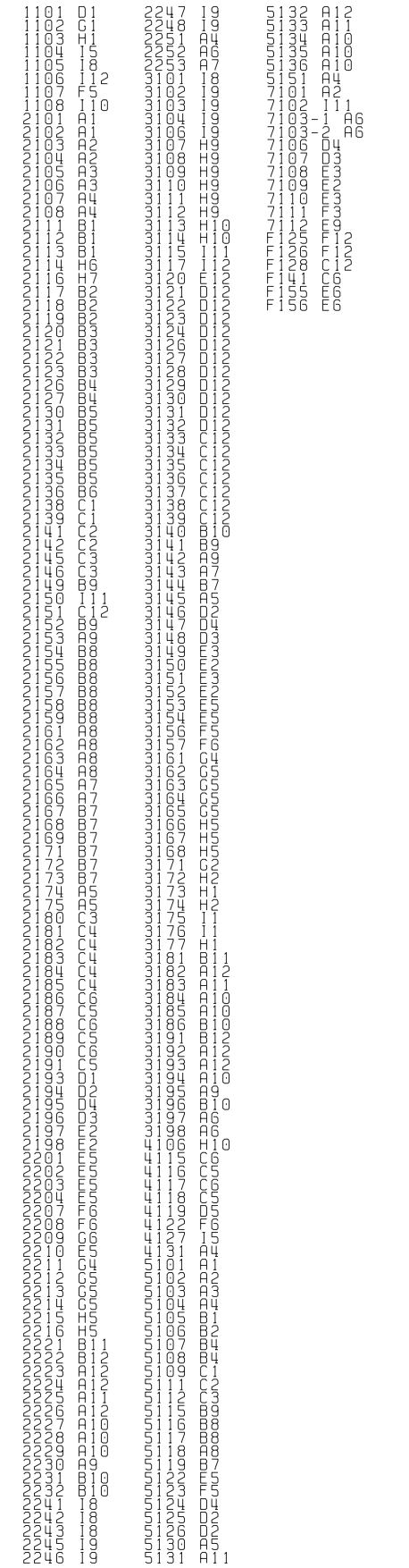

**SCHEMATIC DIAGRAM**

FOR INFORMATION ONLY (NO SERVICE PARTS WILL BE AVAILABLE)

The first digit of a component indicates the component type.

- 1xxx : Connector    3xxx : Resistor    5xxx : Coil    7xxx : IC, Transistor, FET
- 2xxx : Capacitor    4xxx : SMD jumper    6xxx : Diode    9xxx : Wire jumper

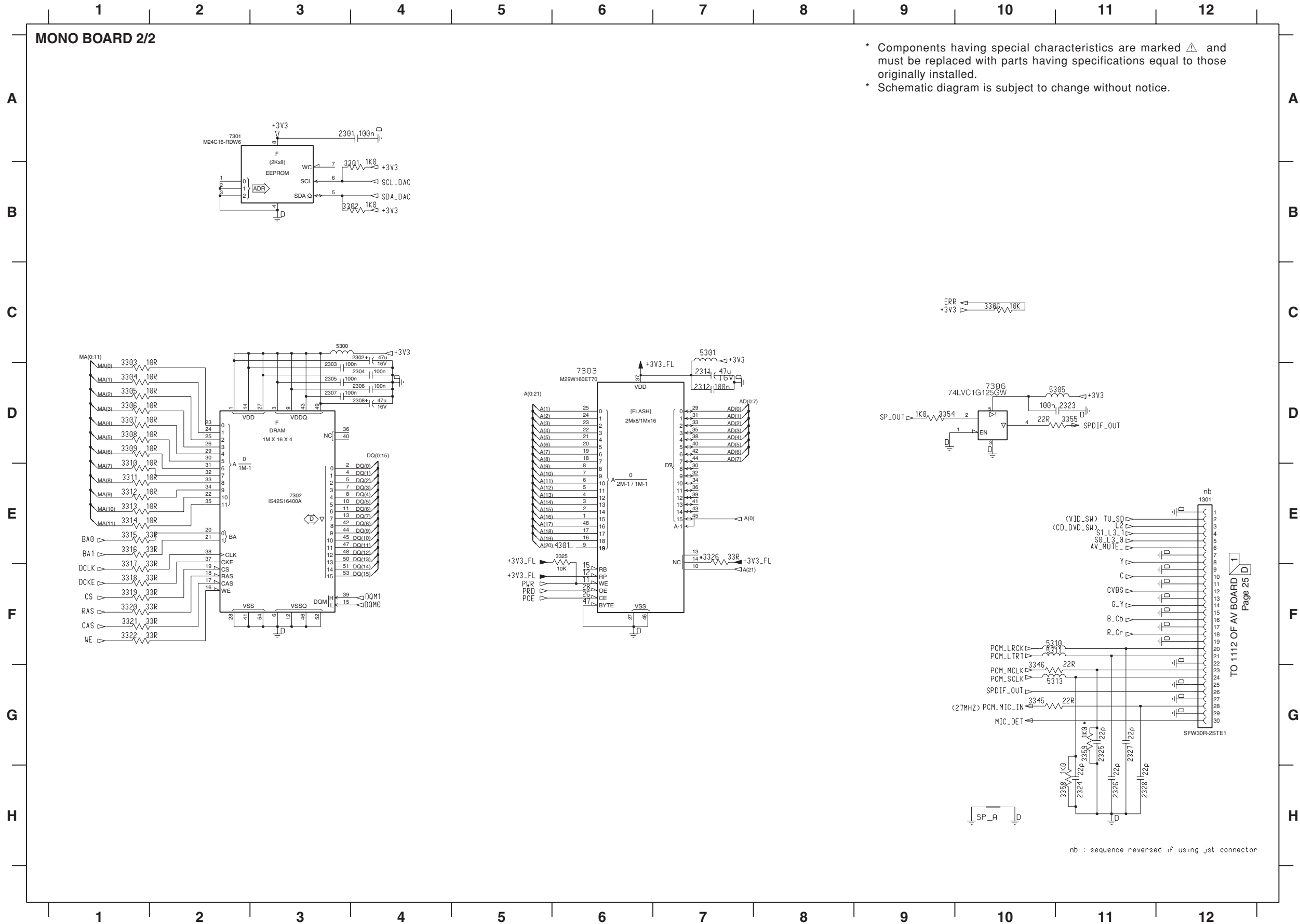

\* Components having special characteristics are marked  $\triangle$  and must be replaced with parts having specifications equal to those originally installed.  
 \* Schematic diagram is subject to change without notice.

- 1301 E12
- 2301 A3
- 2302 D4
- 2303 D3
- 2304 D4
- 2305 D3
- 2306 D4
- 2307 D3
- 2308 D4
- 2311 D7
- 2312 D7
- 2323 D11
- 2324 H11
- 2326 H11
- 2327 G11
- 2328 H11
- 3301 B4
- 3302 B4
- 3303 D1
- 3304 D1
- 3305 D1
- 3306 D1
- 3307 D1
- 3308 D1
- 3309 D1
- 3310 E1
- 3311 E1
- 3312 E1
- 3313 E1
- 3314 E1
- 3315 E1
- 3316 E1
- 3317 F1
- 3318 F1
- 3319 F1
- 3320 F1
- 3321 F1
- 3322 F1
- 3325 E6
- 3326 E7
- 3345 G10
- 3346 G10
- 3354 D9
- 3355 D11
- 3358 H11
- 3359 G11
- 3386 C10
- 4301 E6
- 5300 C3
- 5301 C7
- 5305 D10
- 5310 F10
- 5311 F10
- 5313 G10
- 7301 A2
- 7302 D2
- 7303 D6
- 7306 D10

TO 1112 OF AV BOARD Page 25 D

nb : sequence reversed if using jst connector

**SCHEMATIC DIAGRAM**

FOR INFORMATION ONLY (NO SERVICE PARTS WILL BE AVAILABLE)

The first digit of a component indicates the component type.

1xxx : Connector    3xxx : Resistor    5xxx : Coil    7xxx : IC, Transistor, FET

2xxx : Capacitor    4xxx : SMD jumper    6xxx : Diode    9xxx : Wire jumper

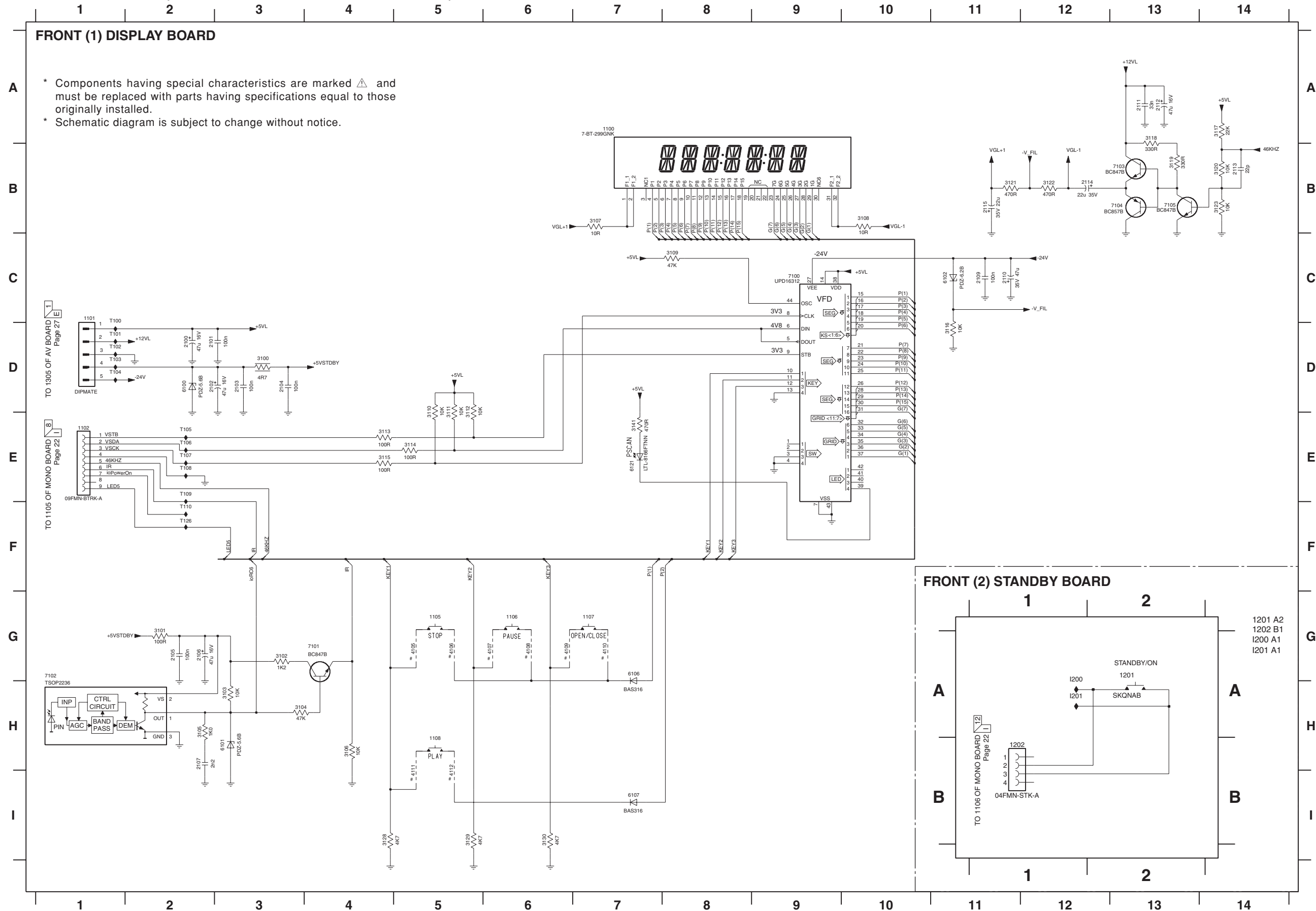

- 1100 A7
- 1101 C1
- 1102 E1
- 1103 A1
- 1104 C1
- 1105 G5
- 1106 G6
- 1107 G7
- 1108 H5
- 2100 D2
- 2101 D2
- 2102 D2
- 2103 D3
- 2104 D3
- 2105 G2
- 2106 G2
- 2107 H2
- 2109 C11
- 2110 C11
- 2111 A13
- 2112 A13
- 2113 B14
- 2114 B12
- 2115 B11
- 3100 D3
- 3101 D2
- 3102 G3
- 3103 H3
- 3104 H3
- 3105 H2
- 3106 H4
- 3107 B7
- 3108 B10
- 3109 C8
- 3110 D5
- 3111 D5
- 3112 D5
- 3113 E4
- 3114 E5
- 3115 E4
- 3116 D11
- 3117 A14
- 3118 A13
- 3119 B13
- 3120 B14
- 3121 B11
- 3122 B12
- 3123 B14
- 3128 I4
- 3129 I5
- 3130 I6
- 3132 G10
- 3141 E7
- 4103 H5
- 4105 G5
- 4106 G5
- 4107 G6
- 4108 G6
- 4109 G6
- 4110 G7
- 4111 H5
- 4112 H5
- 6100 D2
- 6101 H3
- 6102 C11
- 6106 G7
- 6107 I7
- 6121 E7
- 7100 C9
- 7101 G4
- 7102 G1
- 7103 B13
- 7104 B13
- 7105 B13
- 7106 G11
- T100 C1
- T101 D1
- T102 D1
- T103 D1
- T104 D1
- T105 E2
- T106 E2
- T107 E2
- T108 E2
- T109 E2
- T110 F2
- T111 A2
- T112 A2
- T113 A2
- T114 A2
- T115 A2
- T116 A2
- T117 A2
- T118 A2
- T119 B2
- T120 B2
- T121 B2
- T122 B2
- T123 B2
- T124 B2
- T125 B2
- T126 F2



SCHEMATIC DIAGRAM

FOR INFORMATION ONLY (NO SERVICE PARTS WILL BE AVAILABLE)

The first digit of a component indicates the component type.

1xxx : Connector    3xxx : Resistor    5xxx : Coil    7xxx : IC, Transistor, FET

2xxx : Capacitor    4xxx : SMD jumper    6xxx : Diode    9xxx : Wire jumper

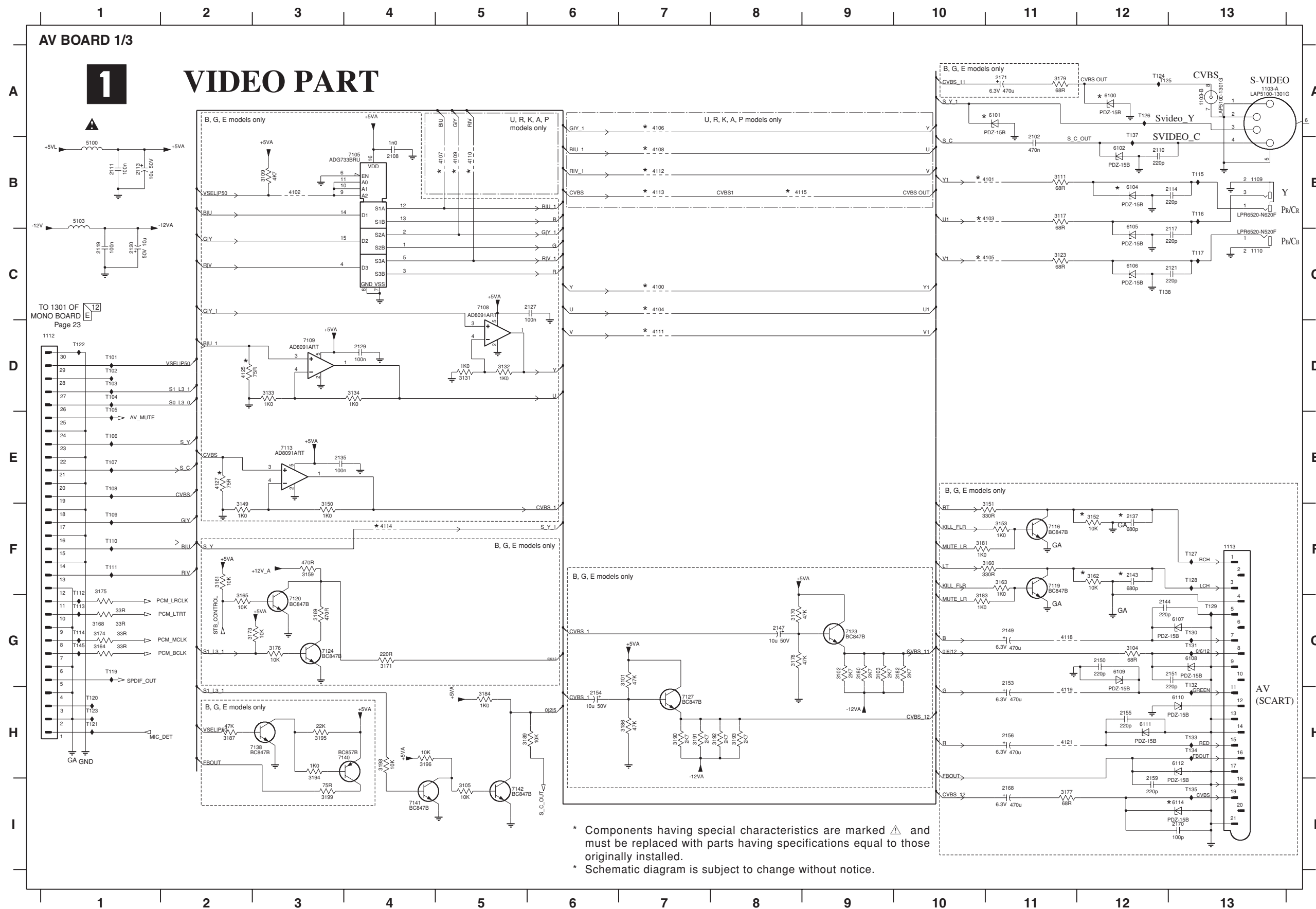

1103-A A13	4127 E2
1103-B A13	5100 B1
1109 B13	5103 B1
1110 C13	6101 A11
1111 C13	6102 B12
1112 D1	6104 B12
1113 F13	6105 B12
2102 B11	6106 C12
2108 B4	6107 G13
2109 B8	6108 G13
2110 B12	6109 G12
2111 B1	6110 H13
2113 B1	6111 H12
2114 B13	6112 H13
2117 C13	6114 I13
2119 C1	7104 B9
2120 C1	7105 B4
2121 C13	7108 C5
2127 C6	7109 D3
2129 D4	7113 E3
2135 E3	7116 F11
2137 F12	7119 F11
2143 F12	7120 G3
2144 G12	7123 G9
2147 G8	7124 G3
2149 G11	7127 H7
2150 G12	7138 H2
2151 G13	7140 H4
2153 G11	7141 I4
2154 H6	7142 I5
2155 H12	T101 D1
2156 H11	T102 D1
2159 I12	T103 D1
2168 I11	T104 D1
2170 I13	T105 D1
2171 A11	T106 E1
3101 G7	T107 E1
3102 G9	T108 E1
3103 G9	T109 F1
3104 G12	T110 F1
3105 I5	T111 F1
3108 A8	T112 F1
3109 B3	T113 G1
3110 B8	T114 G1
3111 B11	T115 B13
3112 B9	T116 B13
3113 B9	T117 C13
3114 B9	T119 G1
3115 B10	T120 H1
3117 B11	T121 H1
3123 C11	T122 D1
3131 D5	T123 H1
3132 D5	T124 A12
3133 D3	T126 A12
3134 D4	T127 F13
3149 F2	T128 F13
3150 F3	T129 G13
3151 F11	T130 G13
3152 F12	T131 G13
3153 F11	T132 G13
3159 F3	T133 H13
3160 F11	T134 H13
3161 F2	T135 I13
3162 F12	T137 A12
3163 F11	T138 C12
3164 G1	T139 C12
3165 G2	T140 D12
3166 G4	T141 D12
3169 G3	T142 D12
3170 G8	T143 D12
3171 G4	T144 E12
3173 G2	T145 G1
3174 G1	
3175 F1	
3176 G3	
3177 I11	
3178 G8	
3179 A11	
3180 G9	
3181 F10	
3182 G10	
3183 G10	
3184 H5	
3186 H7	
3187 H2	
3189 H5	
3190 H7	
3191 H7	
3192 H8	
3193 H8	
3194 H3	
3195 H3	
3196 H4	
3198 H4	
3199 J3	
4100 C7	
4101 B11	
4102 B3	
4103 B11	
4104 C7	
4105 C11	
4106 B7	
4107 B5	
4108 B7	
4109 B5	
4110 B5	
4111 D7	
4112 B7	
4113 B7	
4114 F4	
4115 B8	
4118 G11	
4119 H11	
4121 H11	
4125 D2	

\* Components having special characteristics are marked  $\Delta$  and must be replaced with parts having specifications equal to those originally installed.

\* Schematic diagram is subject to change without notice.

■ SCHEMATIC DIAGRAM

FOR INFORMATION ONLY (NO SERVICE PARTS WILL BE AVAILABLE)

The first digit of a component indicates the component type.

1xxx : Connector    3xxx : Resistor    5xxx : Coil    7xxx : IC, Transistor, FET

2xxx : Capacitor    4xxx : SMD jumper    6xxx : Diode    9xxx : Wire jumper

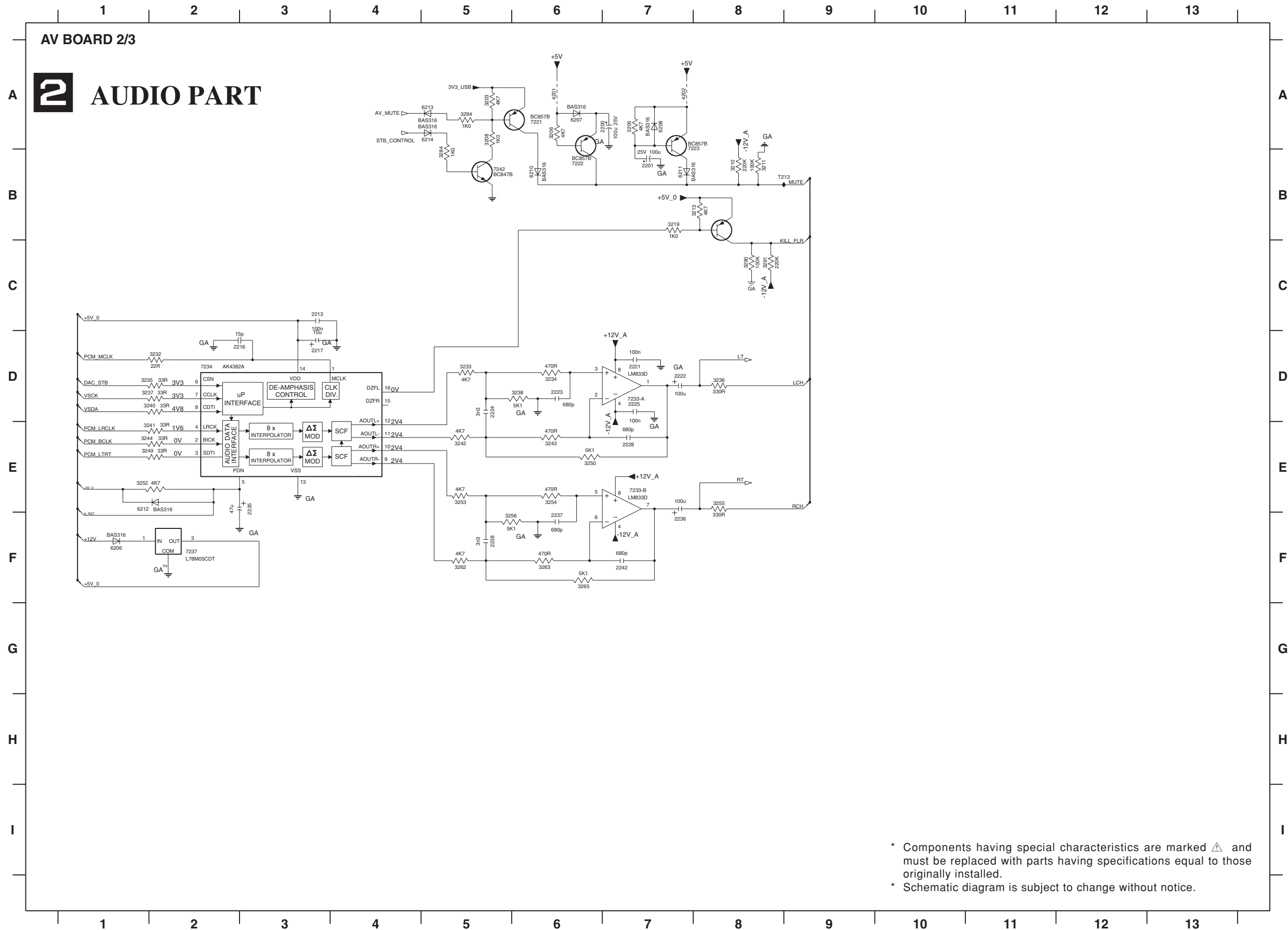

- 2200 A7
- 2201 B7
- 2212 C3
- 2213 C3
- 2216 D2
- 2217 D3
- 2221 D7
- 2222 D7
- 2223 D6
- 2224 D5
- 2225 D7
- 2228 E7
- 2235 E3
- 2236 F7
- 2237 F6
- 2238 F5
- 2242 F7
- 3203 A5
- 3205 A7
- 3206 A6
- 3208 A5
- 3210 B8
- 3211 B8
- 3213 B8
- 3219 B7
- 3232 D2
- 3233 D5
- 3234 D6
- 3235 D1
- 3236 D8
- 3237 D1
- 3238 D6
- 3240 D2
- 3241 E2
- 3242 E5
- 3243 E6
- 3244 E1
- 3249 E1
- 3250 E6
- 3252 E1
- 3253 E5
- 3254 E6
- 3255 E8
- 3256 F5
- 3262 F5
- 3263 F6
- 3265 F6
- 3264 B5
- 3290 C8
- 3291 C8
- 3294 A5
- 4201 A6
- 4202 A7
- 6206 F1
- 6207 A6
- 6208 A7
- 6210 B6
- 6211 B7
- 6212 E1
- 6213 A5
- 6214 A5
- 6215 G3
- 7221 A6
- 7222 B6
- 7223 A7
- 7225 C8
- 7233-A D7
- 7233-B E7
- 7234 D2
- 7237 F2
- 7242 B5
- T201 A3
- T202 A2
- T203 A4
- T204 A3
- T205 A3
- T206 A2
- T207 A2
- T208 A3
- T209 A2
- T210 A3
- T211 A2
- T212 B3
- T213 B8
- T216 A3

\* Components having special characteristics are marked  $\Delta$  and must be replaced with parts having specifications equal to those originally installed.  
 \* Schematic diagram is subject to change without notice.

**SCHEMATIC DIAGRAM**

FOR INFORMATION ONLY (NO SERVICE PARTS WILL BE AVAILABLE)

The first digit of a component indicates the component type.

- 1xxx : Connector    3xxx : Resistor    5xxx : Coil    7xxx : IC, Transistor, FET
- 2xxx : Capacitor    4xxx : SMD jumper    6xxx : Diode    9xxx : Wire jumper

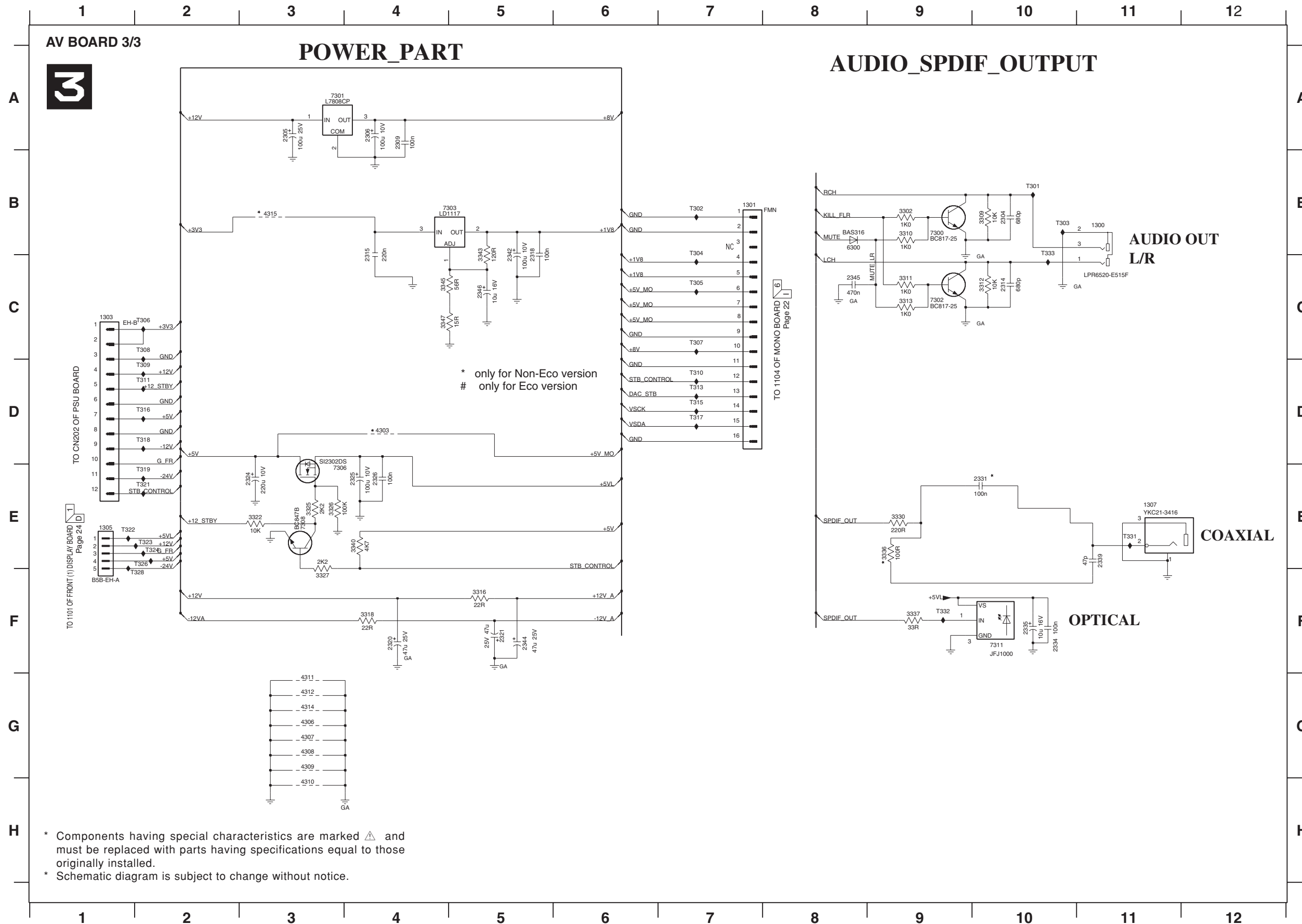

\* Components having special characteristics are marked  $\Delta$  and must be replaced with parts having specifications equal to those originally installed.  
 \* Schematic diagram is subject to change without notice.

EXPLODED VIEW

When disassembling, use the special screw driver with such tip shape as shown in figure.

T10 2.7 mm

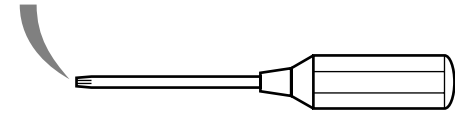

- 250 3 x 6 S-Tight with the brim
- 255 3 x 4 S-Tight Black
- 256 3 x 6 S-Tight Black
- 260 3 x 8 P-Tight Black

DVD Module

- The DVD Mechanism and Mono Board together as a set are called the DVD Module.
- If a failure has occurred with any part of the DVD Module, be sure to replace the DVD Module as a whole.
- Neither the DVD Mechanism nor Mono Board can be replaced independently.

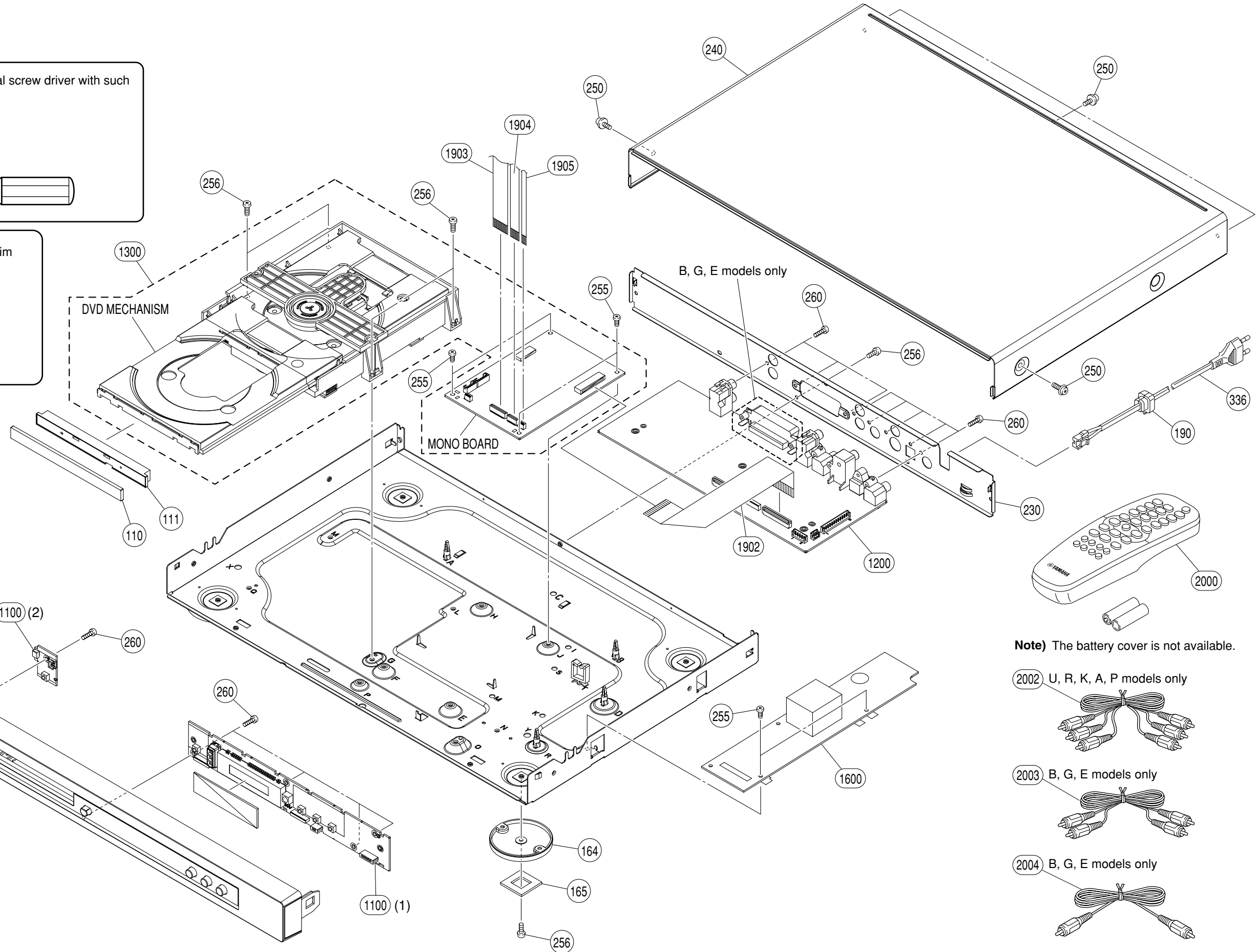

Note) The battery cover is not available.

2002 U, R, K, A, P models only

2003 B, G, E models only

2004 B, G, E models only

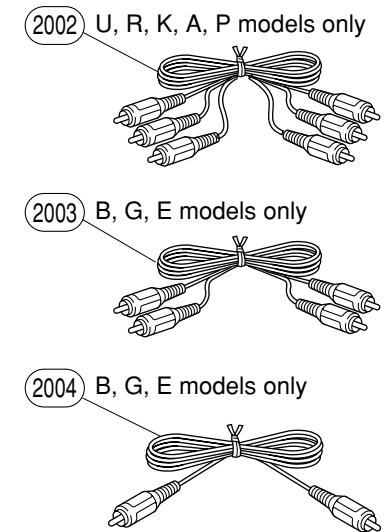

## MECHANICAL PARTS

### WARNING

- Components having special characteristics are marked  $\triangle$  and must be replaced with parts having specifications equal to those originally installed.

Ref. No.	PART NO.	Description	Remarks	Markets	
* 101	AAX59610	FRONT PANEL ASS'Y	S550GD	3141 079 02931	RK
* 101	AAX59590	FRONT PANEL ASS'Y	S550BL	3141 079 02911	UABGEP
* 101	AAX59600	FRONT PANEL ASS'Y	S550TI	3141 079 02921	UGE
* 101		FRONT PANEL ASS'Y	S550SI		BGE
* 101	AAX59620	FRONT PANEL ASS'Y	S5750BL	3141 079 02941	U
* 101	AAX59630	FRONT PANEL ASS'Y	S5750SI	3141 079 02951	UA
* 110	AAX58300	TRAY COVER		3139 244 05121	
* 111	AAX58310	TRAY CATCH		3139 244 05131	
* 164	AAX59120	FOOT	GD	3139 244 05411	
* 164	AAX58460	FOOT	BL, TI, SI	3139 244 05111	
* 165	AAX58260	CUSHION		3139 243 10181	
190	AAX53540	BUSH	450H259010	3139 114 26671	
* 230	AAX59100	REAR PANEL	S550	3139 241 22152	UAP
* 230	AAX59110	REAR PANEL	S550	3139 241 22301	RK
* 230	AAX58440	REAR PANEL	S550	3139 241 22151	BGE
* 230	AAX59090	REAR PANEL	S5750	3139 241 22141	UA
* 240	AAX59020	TOP COVER	GD	3139 241 22391	
* 240	AAX58270	TOP COVER	BL	3139 241 22171	
* 240	AAX58290	TOP COVER	TI	3139 241 22191	
* 240	AAX58280	TOP COVER	SI	3139 241 22181	
250	AAX57730	PW HEAD TORX S-TIGHT SCREW	GD 3x6 MFN133	3103 301 45951	
250	AAX55450	PW HEAD TORX S-TIGHT SCREW	BL 3x6 MFZN2BL	3139 110 40611	
250	AAX53440	PW HEAD TORX S-TIGHT SCREW	TI,SI 3x6 MFN133	3104 120 40081	
255	AAX55930	PAN HEAD TORX S-TIGHT SCREW	3x4 MFZN2BL	3141 010 40591	
256	AAX23640	PAN HEAD TORX S-TIGHT SCREW	3x6 MFZN2BL	2511 077 00039	
260	AAX53520	PAN HEAD TORX P-TIGHT SCREW	3x8 MFZN2BL	2511 076 50012	
* $\triangle$ 336	AAX47750	POWER CABLE	1.8m	2422 070 98235	U
$\triangle$ 336	AAX53630	POWER CABLE	1.8m	2422 070 98231	RGEP
* $\triangle$ 336	AAX59130	POWER CABLE	1.8m	2422 070 98222	K
* $\triangle$ 336	AAX47740	POWER CABLE	1.8m	2422 070 98233	A
* $\triangle$ 336	AAX58470	POWER CABLE	1.8m	3103 140 25882	B
* 1100	AAX58190	P.C.B. ASS'Y	FRONT	3139 248 83061	
* 1200	AAX59010	P.C.B. ASS'Y	A/V	3139 248 83151	URKAP
* 1200	AAX58170	P.C.B. ASS'Y	A/V	3139 248 83161	BGE
* 1300	AAX58160	DVD MODULE	MODULE SD6.1 PL	3139 117 10641	
* 1600	AAX58480	POWER SUPPLY UNIT	HE 2004 MIT	3139 248 72062	
* 1902	AAX58250	FLEXIBLE FLAT CABLE	30P 120mm P=1mm	3139 241 00541	
* 1903	AAX58220	FLEXIBLE FLAT CABLE	16P 220mm P=1mm	3139 111 02421	
* 1904	AAX58230	FLEXIBLE FLAT CABLE	9P 140mm P=1mm	3139 241 00521	
* 1905	AAX58240	FLEXIBLE FLAT CABLE	4P 400mm P=1mm	3139 241 00531	
		ACCESSORIES			
* 2000	AAX58450	REMOTE CONTROL		3139 248 71873	
2002	AAX23450	AUDIO/VIDEO PIN CABLE	YE/RD/WH 1.5m 1pc	2422 076 00304	URKAP
2003	AAX21980	AUDIO PIN CABLE	RD/WH 1.5m 1pc	3103 308 92611	BGE
2004	AAX22970	VIDEO PIN CABLE	YE 1.5m 1pc	3104 108 45432	BGE
		BATTERY	UM-3 (2pcs)		

\* New Parts

# DVD-S550/DV-S5750

---

